



## **Abso Charger**

**12V 20A (AC1220)**  
**12V 40A (AC1240)**  
**12V 60A (AC1260)**  
**24V 30A (AC2430)**

## **Owner's Manual**



For safe and optimum performance, the **KISAE Abso Charger** must be used properly. Carefully read and follow all instructions and guidelines in this manual and give special attention to the **CAUTION** and **WARNING** statements.

## PLEASE KEEP THIS MANUAL FOR FUTURE REFERENCE

### Disclaimer

While every precaution has been taken to ensure the accuracy of the contents of this guide, **KISAE Technology** assumes no responsibility for errors or omissions. Note as well that specifications and product functionality may change without notice.

### Important

Please be sure to read and save the entire manual before using your **KISAE Abso Charger**. Misuse may result in damage to the unit and/or cause harm or serious injury.

### Product Numbers

<b>AC1220</b>	<b><i>Abso Charger 20A</i></b>
<b>AC1240</b>	<b><i>Abso Charger 40A</i></b>
<b>AC1260</b>	<b><i>Abso Charger 60A</i></b>
<b>AC2430</b>	<b><i>Abso Charger 30A 24V</i></b>

### Document Part Number

**MU AC1220** Rev C

### Service Contact Information

Email: [info@kisaetechnology.com](mailto:info@kisaetechnology.com)

Phone : 1 877 897-5778

Web : [www.kisaetechnology.com](http://www.kisaetechnology.com)

## Table of Contents

1.	INTRODUCTION .....	4
2.	PRODUCT DESCRIPTION .....	5
3.	UNDERSTANDING THE UNIT .....	5
4.	INSTALLING THE CHARGER .....	9
5.	UNIT OPERATION .....	12
6.	SPECIFICATIONS .....	17
7.	WARRANTY.....	18
	Appendix A1	
	Appendix A2	
	Appendix B	

# 1. INTRODUCTION

Thank you for purchasing the **KISAE Abso Charger**. With our state of the art, easy to use design, this product will offer you reliable service by providing a multi-stage multi-bank battery charger to charge different types of batteries you have installed in your boat, RV, vehicle or your cabin battery bank.

An innovative feature we offer is the ability to charge your main battery bank as first priority so that you may charge this main bank quickly. Another unique feature is our silent mode setting that reduces the charging current at night, thereby reducing the fan noise.

This manual will explain how to use this unit safely and effectively. Please read and follow these instructions and precautions carefully.

## IMPORTANT SAFETY INFORMATION

This section contains important safety information for the **KISAE Abso Charger**. Each time, before using the unit, READ ALL instructions and cautionary markings on or provided with the unit, and all appropriate sections of this guide. The **KISAE Abso Charger** contains no user-serviceable parts. See Warranty section for how to handle product issues.

### **WARNING: Fire and/or Chemical Burn Hazard!**

Do not cover or obstruct any air vent openings and/or install in a zero-clearance compartment.

**WARNING: Failure to follow these instructions can result in death or serious injury. Keep away from children!**

- When working with electrical equipment or lead acid batteries, have someone nearby in case of an emergency.
- Study and follow all the battery manufacturer's specific precautions when installing, using and servicing the battery connected to the charger.
- Wear eye protection and gloves.
- Avoid touching your eyes while using this unit.
- Keep fresh water and soap on hand in the event battery acid comes in contact with eyes. If this occurs, cleanse right away with soap and water for a minimum of 15 minutes and seek medical attention.
- Batteries produce explosive gases. **DO NOT** smoke or have an open spark or fire near the system.
- Keep unit away from moist or damp areas. Never expose unit to snow, water etc.
- Avoid dropping any metal tool or object on the battery. Doing so could create a spark or short circuit which goes through the battery or another electrical tool that may create an explosion.

### **WARNING: Explosion hazard!**

- Do not use the unit in the vicinity of flammable fumes or gases (such as propane tanks or large engines).
- Avoid covering the ventilation openings. Always operate unit in an open area.
- Prolonged contact to high heat or freezing temperatures will decrease the working life of the unit.

### **CAUTION:**

- This appliance is not intended for use by persons (including children) with reduced physical, sensory or mental capabilities, or lack of experience and knowledge, unless they have been given supervision or instruction concerning use of the appliance by a person responsible for their safety.
- Children should be supervised to ensure that they do not play with the appliance.
- Do not charge non-rechargeable batteries because of the danger of eruption.
- During charging, batteries be placed in the ventilated area.
- The battery terminal not connected to the chassis has to be connected first.
- The other connection is to be made to the chassis, remote from the battery and fuel line. The battery charger is then to be connected to the supply mains.
- After charging, disconnect the battery charger from the supply mains. Then remove the chassis connection and then the battery connection.
- Only allow children at least 8 years old to use the battery charger. Give sufficient instruction so that the child is able to use the battery charger in a safe way and explain that it is not a toy

and must not be played with.

- The child does not try to charge non-rechargeable batteries because of the danger of eruption.
- Examine the battery charger regularly for damage, especially the cord, plug and enclosure. If the battery charger is damaged, it must not be used until it has been repaired.

## FCC INFORMATION

This equipment has been tested and found to comply with the limits for a Class B digital device, pursuant to part 15 of the FCC Rules. These limits are designed to provide reasonable protection against harmful interference in a residential installation. This equipment generate, uses and can radiate radio frequency energy and, if not installed and used in accordance with the instructions, may cause harmful interference to radio communications. However, there is no guarantee that interference will not occur in a particular installation. If this equipment does cause harmful interference to radio or television reception, which can be determined by turning the equipment off and on, the user is encouraged to try to correct the interference by one or more of the following measures:

- Reorient or relocate the receiving antenna.
- Increase the separation between the equipment and the receiver.
- Connect the equipment into an outlet on a circuit different from that to which the receiver is connected.
- Consult the dealer or an experienced radio/TV technician for help.

## LIMITATIONS ON USE

Do not use in connection with life support systems or other medical equipment or devices.

## 2. PRODUCT DESCRIPTION

The **KISAE Abso Charger** includes the items listed below.

- Base unit
- Owner's manual

Series	Model No.	Rating
12V Model	AC1220	20A, 12V
	AC1240	40A, 12V
	AC1260	60A, 12V
24V Model	AC2430	30A, 24V

## 3. UNDERSTANDING THE UNIT

The **KISAE Abso Charger** is a fully automatic multistage battery charger with the ability to charge 3 separate battery banks. When first connected to an AC power source, the charger will check all three battery banks before charging commences. The charger operates on an isolated charging design where Battery Bank 1 is separate from Battery Bank 2 and 3. Battery Bank 1 is the priority battery bank in the charging sequence and must be connected to the main (or primary house) battery bank. Battery Bank 1 can be programmed with a different charge algorithm over Bank 2 and 3.

Battery Bank 2 and 3 are connected in parallel internally (with a separation diode) and share a common charge algorithm.

During normal operation the charger will do a full charge cycle to float stage on Battery Bank 1 with battery type set to either **GEL**, **AGM**, **FLOODED** or **LITHIUM** (see Lithium section for limitations of use). Once float stage is reached the charger transition to charge Battery Banks 2 and 3 together with a bulk / absorption mode (Battery Banks 2 and 3 can be set to either **GEL**, **AGM** or **FLOODED**). On completion all three battery banks move to float stage with a shared battery voltage determined by Battery Bank 1 settings. This setting allows the charger to remain permanently connected to mains if required. See more details on Appendix B.

**Important Note:** Battery Bank 1 on the charger should only be connected to the main battery bank for first priority charging and Battery Banks 2 and 3 on the charger to be connected to the other battery banks with lower priority (such as jump-start battery bank and/or AC generator battery bank used in marine application). On single bank installations DO NOT use Battery Bank 2 and 3.

**Silent Mode:**

A unique feature of the **KISAE Abso Charger** is the ability to disable the cooling fan for total silent operation at night or whenever required. This setting is manually activated via the display and remains active for a period of 12 hours, or unit manually deactivated. Please note that charger output will be reduced while in Silent Mode, leading to longer required recharge times. When the Silent Mode is activated, the 'Auto' icon is show on the Digital Display.

**Multi-Stage Charging Process:**

The charger is a fully automatic, set and forget charger. It is designed to quickly and accurately recharge deep cycle batteries utilizing charger algorithms that help to maximize the life of specialized deep cycle batteries.

The charger feature multistage smart charging technology that enables the charger to be connected to the battery banks permanently.

As dictated by battery manufacturer's recommendations, deep cycle batteries require a multi-stage charge sequence for perfect, fast and accurate charging. This charger delivers four primary charge stages (Bulk Charge, Absorption Charge, Float and Maintenance).

**Bulk Charge:** The battery is charged at full rated output current of the charger until the battery reaches the final charging voltage, known as its absorption voltage. In this step, around 80% of the battery is recovered as fast as possible.

**Absorption Charge:** With the charger voltage held steady, the remains 20% is replaced with the charger allowing the current to drop as the battery approaches its full charge.

**Float Stage:** Finally, in the float stage the charger voltage is lowered and held at a constant and safe predetermined level. This prevents the battery from being overcharged, yet allows the charger to supply enough current to make up for the self-discharge losses of the battery, while supporting any additional loads connected to the battery (such as DC lighting and refrigerators). This stage allows for the charger to be used as a DC power supply.

**Maintenance:** This is a regular timed recharge (or return to bulk stage). The charger switches from float stage to bulk charge after 7 days of constant operation to ensure the battery banks remain active.

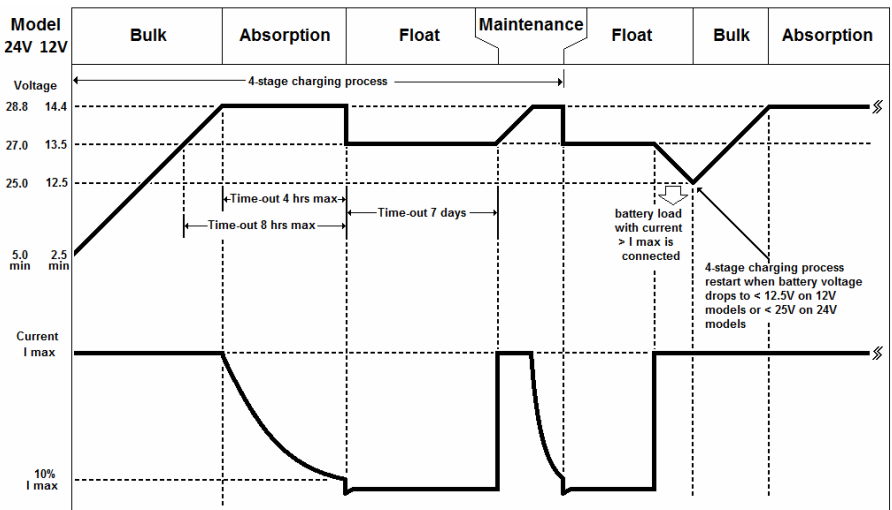

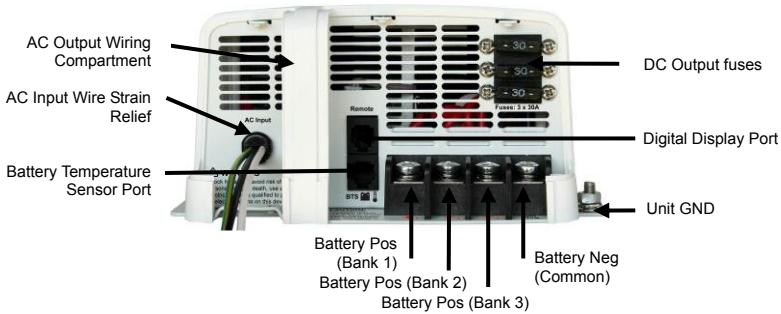

Picture shown **AC1260** model

Typical wiring block diagram of the Battery Charger with 3 batteries bank:

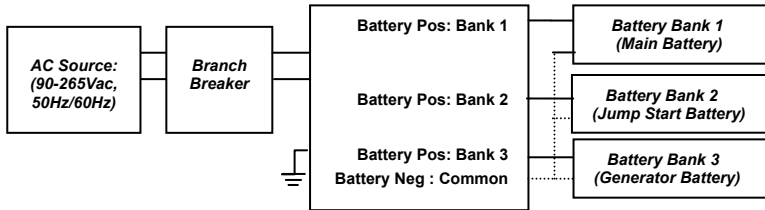

**Battery Bank 1, 2 and 3 setting:**

There are two main settings required on the charger for battery charging:

Battery Bank 1 Setting (CH 1):

- Battery type (**GEL, AGM, Flooded, Lithium**)
- Maximum charging current ('**h-current**' in A)
- Absorption to float stage current ('**L-current**' in A - **GEL, AGM, Flooded** battery type only)
- Number of charging stages (Mode 2 – Bulk and Absorption stage only, Mode 3 – Bulk, Absorption and Float stage)
- Battery temperature (Low- '**Lo**', Normal – '**nor**', High – '**hi**')
- Charge voltage (14.2, 14.3, 14.4 in V - **Lithium** battery type only)
- Charge voltage for Lithium Battery type setting  
**AC1220, AC1240, AC1260:** 13.9, 14.0, 14.1, 14.2, 14.3, 14.4 V  
**AC2430:** 27.8, 28.0, 28.2, 28.4, 28.6, 28.8 V
- Charge termination current ('**L-current**' in A - **Lithium** battery type only)

Battery Bank 2 and 3 Setting (CH 2 and 3):

- Battery type (**GEL, AGM, Flooded** only, not applicable for **Lithium** battery)
- Maximum charging current ('**h-current**' in A)
- Absorption to float stage current ('**L-current in A**' – **GEL, AGM, Flooded** battery type only)

The charger can also be set to Power Supply Mode (Program setting on CH 1). With this setting, the charger will only provide constant voltage and current to Battery Bank 1 (CH 1) only, Battery Bank 2 and 3 (CH 2 & 3) are disabled. Even with battery banks are connected to the two banks, no DC voltage or current will be supplied to these two banks. The charger will act as a constant voltage power supply with user selected supply voltage and maximum current.

**Branch Breaker:**

For AC Input hardwire charging systems, it is required to use a 15A branch breaker to connect between the AC source and the charger AC input.

**AC Source:**

The charger accepts full universal input voltage (90-265Vac, 47-63Hz).

### Digital Display Port:

The Digital Display Port has dual functions. It can be used for optional external display or for PC interface.

#### Use for external display

The interface port is used for connecting an optional external display. The external display (sold separately) has identical functions to the built-in unit display.

#### Use for PC interface

- A **KISAE Abso Charger** PC Interface Kit (sold separately) is available and is used to connect between the port and the PC. This can be used to monitor and made changes to the settings.
- Full details of the **KISAE Abso Charger** PC Interface Kit, it can be found on the KISAE website [www.kisaetechnology.com](http://www.kisaetechnology.com) and you can also consult your dealer for more details.

### Battery Temperature Sensor Port:

**CAUTION: RISK OF BATTERY DAMAGE.** If temperature sensor is not being used, never set the battery temperature lower than the actual temperature. This may **overcharge and damage** the battery.

**KISAE Abso Charger** Temperature Sensor (sold separately) is available and is used to connect to one of the negative terminals of the battery. It measures the battery temperature and will make small adjustments to the battery charging voltage for better battery charging performance. As Battery Bank 1 is designed for charging the main battery bank on the system, it is highly recommended to have the battery temperature sensor connected to Battery Bank 1's battery. If the temperature sensor is not used, you can also manually set the temperature to Low – 'Lo', Normal – 'nor', or High – 'hi' to reflect the environmental temperature for better charging effect. Manufacturing default setting is set to 'Normal' temperature. See more details on **Understanding the Battery Temperature Function** in Section 5.

### Digital Display:

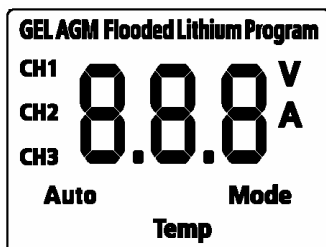

- 'CH1', 'CH2' and 'CH3' represent Battery Bank 1, 2 and 3 respectively. With 'CH1' turned on, the numerical value on the display shows individual battery information like battery voltage in 'V' or charging current in 'A'. 'CH 2' and 'CH 3' will always turn on together, the numerical value on the display shows the total charging current in 'A'
- 'GEL', 'AGM', 'Flooded', 'Lithium' and 'Program' represent different battery types setting.
- 'Auto' indicates Silent Mode is activated.
- 'Mode' only turns on during the setting of charging stage (Mode 2 - (2 stages): Bulk and Absorption stage only, or Mode 3 - (3-stages): Bulk, Absorption and Float stage).
- 'Temp' only turns on during the setting of battery temperature.

### Battery Charger Charging Voltage:

12V Model: AC1220, AC1240, AC1260			
Battery Type	Absorption	Float	Equalization
GEL	14.2 V	13.8 V	N.A.
AGM	14.3 V	13.4 V	N.A.
Flooded	14.4 V	13.5 V	16.0 V (See Note 1)
Lithium	Constant 13.9 – 14.4V (0.1V Step, See Note 2)		N.A
Program (Power Supply)	Constant 13.3 – 13.7V (0.2V Step, See Note 3)		N.A

24V Model: AC2430			
Battery Type	Absorption	Float	Equalization
GEL	28.4 V	27.6 V	N.A.
AGM	28.6 V	26.8 V	N.A.
Flooded	28.8 V	27.0 V	32.0 V (See Note 1)
Lithium	Constant 27.8 – 28.8 V (0.2 V Step, See Note 2)		N.A
Program (Power Supply)	Constant 26.6 - 27.4 V (0.4 V Step, See Note 3)		N.A

Note 1: Equalization setting can only be used on flooded battery type selection only. See more details on **Procedure to Equalize the Flooded Battery**.

Note 2: Charger will terminate charging when charging current drop to below the set charger termination value.

Note 3: Charger act as a power supply with selected constant output voltage and preset maximum output currents.



### Battery Bank Size Recommendation:

The battery charging current rating is based on the battery size. Each battery bank should meet the minimum Ah rating as shown. If a smaller size battery bank is used, set the current rating to lower value to match with the battery bank size. Normally, the minimum battery bank capacity is based on twice the charger current rating.

AC1220		AC1240		AC1260		AC2430	
Current Setting	Battery Capacity	Current Setting	Battery Capacity	Current Setting	Battery Capacity	Current Setting	Battery Capacity
5A	Min 10Ah	5A	Min 10Ah	5A	Min 10Ah	5A	Min 10Ah
10A	Min 20Ah	10A	Min 20Ah	20A	Min 40Ah	10A	Min 20Ah
15A	Min 30Ah	20A	Min 40Ah	40A	Min 80Ah	20A	Min 40Ah
20A	Min 40Ah	40A	Min 80Ah	60A	Min 120Ah	30A	Min 60Ah

## 4. INSTALLING THE CHARGER

**WARNING:** KISAE Technology recommends that all wiring be done by a certified technician or electrician to ensure adherence to the applicable electrical safety wiring regulations and installation codes. Failure to follow these instructions can damage the unit and could also result in personal injury or loss of life.

**CAUTION:** Before beginning your unit installation, please consider the following:

- The unit should be used or stored in an indoor area away from direct sunlight, heat, moisture or conductive contaminants.
- When placing the unit, allow a minimum of three inches of space around the unit for optimal ventilation.

*Note: The charger is designed to be permanently mounted.*

### Mounting the Charger:

- Choose an appropriate mounting location.
- For installing in an indoor location, the unit can be mounted in any direction.
- For installing in boat or marine environment, the unit can be mounted horizontally and vertically (AC and DC panel facing downwards) only.
- Use the mounting template below to mark the positions of the mounting screws.
- Drill the 4 mounting holes and place the Charger in position and fasten the unit to the mounting surface. See mounting location as below.

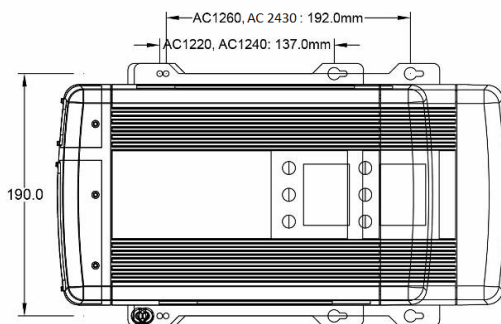

### Chassis Grounding Connection:

**DANGER:** The unit chassis has to be grounded properly. Never operate the Charger without proper grounding. Failure to do so will result in death or serious injury. Ground connection to the charger must comply with all local and application-specific codes and ordinances.

- Connect the unit's chassis ground to the common ground point through the ground stud "Unit GND" located near one of the unit mounting slots. See image in Section 3.

## DC Output Wiring:

**WARNING:** The DC wiring used must be of appropriate size. An individual over-current protection device usually within 7 inches (17.8cm) of each battery bank is required. A DC disconnect switch is also recommended. Both devices must be rated for DC voltage and current and be rated to withstand the short circuit current available from the connected battery bank. Both devices must match with the size of the DC wiring.

### Recommended Cable Length, Size and Required Fuse Size:

Wire Length	Wire Size (AWG/mm <sup>2</sup> ) - Fuse Size (A)		
	AC1220	AC1240, AC2430	AC1260
5' (1.5 m)	#10 / 6mm <sup>2</sup> – 30A	#8 / 12mm <sup>2</sup> – 50A	#6 / 16mm <sup>2</sup> – 80A
7.5' (2.2m)	#10 / 6mm <sup>2</sup> – 30A	#6 / 16mm <sup>2</sup> – 50A	#4 / 25mm <sup>2</sup> – 80A
20' (6m) *	#6 / 16mm <sup>2</sup> – 30A*	#2 / 35mm <sup>2</sup> – 50A*	#1 / 50mm <sup>2</sup> – 80A*

Note: \* Not Recommended

- Remove the DC compartment cover by removing the two screws located on the top surface of the unit near the AC wiring compartment.
- Keep the connection between the battery and the charger as short as possible.
- Connect one end of the positive wire (red wire) to the Battery Bank 1 of charger positive terminal with torque 4.0~5.0 N-m (35~45 lb-in) and the other end to the over current protection device, then the DC disconnect device. Do not over tighten as this may result in damage to the charger.
- Connect another wire from the DC disconnect device to the battery bank.
- For systems with multi-battery banks: Follow the same instruction as on Battery Bank 1 and connect to Battery Bank 2 and 3 accordingly.
- Prepare the negative wire (black wire) and connect to the negative terminal of the charger. Connect the other end of the negative wire to all the negative terminals of the battery bank(s).
- Place the DC Compartment cover back to the original position and secure the cover using the two screws provided.

## AC Input Wiring:

**WARNING:** The AC wiring must be of appropriate size, and it must be protected by an appropriate branch breaker (not provided) connected between the AC source and the charger. A three color coded #14 AWG wire (L, N and GND) with a rated minimum of 75°C wire and a minimum 12 inches in length must be used.

Before connecting AC wiring, make sure the AC source is OFF.

- Remove AC compartment cover by unscrewing the two screws located at the top of the AC compartment cover.
- Remove the top section of the AC Input wire strain relief located at the bottom of the base panel inside the AC wiring compartment by unscrewing the two strain relief mounting screws.
- Use the provided butt-splices to extend the AC Input wires (L, N & GND) to the customer-provided chosen AC wire.
- Feed the extended AC Input wire through the strain relief located at the bottom of the unit's base panel.
- Place the top section of the strain relief back to the original position and secure the AC extended wire by using the strain relief and secure with the two screws provided.
- Connect the other end of the extended AC wire to the chosen branch breaker and connect it to the AC power source. Please verify all the connections from Charger AC Live wire (black color) to black AC extended wire, Charger AC Neutral (white color) to white AC extended wire and AC Charger green wire to AC extended green wire.

## Optional ACRM1201 Remote Display Connection:

### For AC1220, AC1240, AC1260 model:

- To install the optional Remote Display in a specific location, a 6 pin standard RJ12 cable (maximum length 25 ft) is required.
- Install the standard RJ12 cable in your desired location.
- Connect one end of the RJ12 cable to the Digital Display Port and the other end of the cable to the COM\_1 port on the Remote Display Panel. Please note polarity.
- The Remote Display is now ready for use.

**Note:** Do not use COM\_2 on the Remote Display.

**For AC2430 model:**

The 24V model is capable to connect in parallel. Connect two **AC2430** in parallel will provide a total of 24V 60A charging current.

**Use on single AC2430 charger**

- To install the optional Remote Display in a specific location, a 6 pin standard RJ12 cable (maximum length 25 ft) is required.
- Install the standard RJ12 cable in your desired location.
- Connect one end of the RJ12 cable to the Digital Display Port and the other end of the cable to the COM\_1 port on the Remote Display Panel. Please note polarity.
- The Remote Display is now ready for use.

**Note:** Do not use COM\_2 for a single **AC2430** charger connection.

**Use on two AC2430 chargers connected in parallel**

- To install the optional Remote Display in a specific location, two 6 pin standard RJ12 cables (maximum length 25 ft) are required.
- Install the two standard RJ12 cables in parallel in your desired location.
- For the first RJ12 cable, connect one end to the Digital Display port of Charger\_1 and the other end to Remote Display Panel COM\_1 Port.
- For the second RJ12 cable, connect one end to the Digital Display port of Charger\_2 and the other end to Remote Display Panel COM\_2 Port.
- The Remote Display is now ready for use.

**Note 1:** With AC Input available, both Digital Displays will show '**CON**' indicating the two chargers are connected in parallel. The '**INFO**', '**NEXT**' and '**SET**' push buttons on both chargers are disabled. With AC Input not available, press and hold the '**INFO**' button on Charger\_1 will show battery voltage of Bank 1, 2, 3 and then follow with charger firmware revision.

**Note 2:** The combined chargers setting are based on the original setting on Charger\_1. To readjust the combined charger setting, it has to be done through the Remote Display. Before connecting the batteries to the chargers, Battery Bank 1 of Charger\_1 has to connect to Battery Bank 1 of Charger\_2. Battery Bank 2 of Charger\_1 has to connect to Battery Bank 2 of Charger\_2 and Battery Bank 3 of Charger\_1 has to connect to Battery Bank 3 of Charger 2. The Common Ground of both chargers has to be connected together. Damage to both chargers may occur with wrong connection if the above connections are not follows.

**Tips:** During installation or unit setting, it is recommended to pre-set the desire charger setting on Charger\_1 first before connect the 2<sup>nd</sup> RJ12 cable to Charger\_2, as once Charger\_2 is connected, all the three push button on the charger is disable and the display will only show 'Con' and the setting can only be adjusted by using the Remote Panel.

**Optional Temperature Sensor Connection:**

For battery banks connect to a single charger.

- To install the temperature sensor, simply connect the RJ12 plug from the sensor to the RJ12 Temperature Sensor Port on the charger located near the Interface Port.
- On the Temperature Sensor end, simply connect the ring terminals to the negative terminal of one of the chosen battery banks. As Battery Bank 1 is for the main battery bank charging, it is highly recommended to connect the Temperature Sensor to Battery Bank 1 when in use.

For battery banks connect to two AC2430 chargers in parallel:

- Two batteries Temperature Sensor are required.
- Connect RJ12 plug from Temperature Sensor 1 to the RJ12 Temperature Sensor Port on charger 1. On the Temperature Sensor end, simply connect the ring terminals to the positive terminal of the main battery bank.
- Two batteries Temperature Sensor are required.
- Connect RJ12 plug from Charger Temperature Sensor 2 to the RJ12 Temperature Sensor Port on charger 2. On the Temperature Sensor end, simply connect the ring terminals to the negative terminal of the main battery bank.

### **Test the Charger Connection:**

- Switch AC branch breaker switch to ON.
- The display will turn on. Pressing the 'INFO' key will toggle the display to show the factory default setting. The charger is now ready to use.

## **5. UNIT OPERATION**

### **Understanding the Charging Mechanism**

- The charger is a three bank battery charger that is capable of charging a maximum of three battery banks.
- The charger is designed to have Bank 1 charge the main battery bank. Always use Bank 1 first when connected to a single battery bank.
- At start, if the charger senses Battery Bank 2 and 3 had battery connected and the battery voltage is greater than 11V on 12V model (**AC1220, AC1240, AC1260**) or greater than 22V on 24V model (**AC2430**), the charger will then concentrate on fully charging Battery Bank 1 first until it reaches float stage. It will then switch to charge Battery Bank 2 and 3.

Or

- If the charger senses either Battery Bank 2 or 3 had battery connected and the battery voltage is below 11V on 12V model (**AC1220, AC1240, AC1260**) or below 22V on 24V model (**AC2430**), it will cycle to charge Bank 1 for 15 minutes then Bank 2 and 3 together for 15 minutes. When the charger senses both Bank 2 and 3 reached 13V on 12V model (**AC1220, AC1240, AC1260**) or 26V on 24V model (**AC2430**), it will then concentrate on charging Bank 1 until it reaches the float stage. After, it will then concentrate on recharging Bank 2 and 3 to float stage.
- Once all three banks have reached the float stage, the charger will adjust the charging voltage to the preset float voltage and all three banks will be connected in parallel for float stage charging. During the float stage charging stage, each battery bank is separate by an internal separation diode.
- In float stage, see the below chart for the maximum allowable current draw:

	<b>AC 1260</b>	<b>AC 1240</b>	<b>AC 1220</b>	<b>AC 2430</b>
<b>Maximum Float Current</b>	<b>40A</b>	<b>40A</b>	<b>20A</b>	<b>20A</b>

### **For charging GEL, AGM and Flooded batteries:**

- The charger can be set to 'Mode 2', 2 stage charging (Bulk and Absorption stage charging only- no float stage) or 'Mode 3', 3 stage charging – (Bulk, Absorption and Float stage charging).
- Each battery bank can have its own maximum charging current and absorption-to-float mode current settings.

### **For charging Lithium batteries:**

This can only be set at Bank 1, it has its own charging voltage and current setting. It also requires the user to set the charger termination current. The charging process will terminate when the charging current drops to the set termination current.

### **For using charger as Power Supply (Program setting):**

The charger can be used as a constant voltage power supply that will deliver the preset output voltage with the maximum current setting. With this setting, only Bank 1 can be used and the other banks are disabled.

### **Understanding the Digital Display and the Function Keys during Normal Operation:**

During normal operation, the display shows the related channel's battery voltage, charging current and charging stage ('bul' – Bulk stage, 'Abs' – Absorption stage, 'Flo' – Float stage) alternatively. When the 'INFO' key is pressed, it displays other channel's battery voltage only. When all channels reach float stage, the display will show 'Ful' indicating all the batteries connected are fully charged.

During equalization operation on flooded battery, the numerical section on the display will show a flashing 'eq' indicating the equalization process is in progress and it will *not* show the battery voltage or the charging current.

### Understanding the Digital Display Function with no AC Input:

Press and hold the 'INFO' key for 3 seconds to check all the three battery banks voltage so as the charger revision.

### Understanding the Function Key 'INFO', 'NEXT' and 'SET' during Charger Setting:



'INFO': Press and hold the key for longer than 3 seconds to enter charger setting mode and show function setting. Once new setting is done, press 'INFO' again to exit the charger setting mode.

'NEXT': Press the key once to keep or save the chosen setting and change the display to show the next menu to continue other settings.

Note: The selected setting will quickly flash 3 times to acknowledge the setting.

'SET': Press the key to view other available settings or Press and hold the key for 3 seconds to activate or deactivate 'Silent Mode' – 'Auto' icon to show on display. (see more details on Page 6).

### Understanding the Three-Stage (Mode 3) Charging:

The Three-Stage Charging (Mode 3) has a Bulk, then Absorption and then Float sequence. During the Bulk stage, the battery accepts the maximum constant current from the charger. In the Absorption stage, the battery voltage is held to constant voltage and the charging current will slowly reduce. In Float stage, the charger continuously produces lower constant float voltage to fully top up and maintain the battery in a fully charged stage.

The charger will automatically restart the full charging cycle if it senses anyone of the battery bank is discharged to lower than 12.5V for 12V model, 25.0V for 24V model or after seven days in float stage to refresh the battery banks.

### Understanding the Two-Stage (Mode 2) Charging:

The Two-Stage charging is similar to the Three-Stage charging except there is no float stage after the absorption stage. The charger will terminate the battery charging after Absorption.

The charger will automatically restart the full charging cycle if it senses anyone of the battery bank is discharged to lower than 12.5V for 12V model, 25.0V for 24V model or after seven days in float stage to refresh the battery banks.

### Understanding the Battery Temperature Functions:

Optional Battery Temperature Sensor **KISAE Part Number #BTS-10K** is highly recommended with the charger to protect your battery and provide better charging voltage accuracy.

When the battery temperature sensor is used, it is highly recommended to be installed on the main battery bank - Bank 1. The sensor senses the battery temperature and override the manual temperature setting and makes small adjustments to the charging voltage.

Battery Temperature	Battery Charging Voltage Adjustment from 25 °C normal setting			
	Flooded and GEL type		AGM type	
	12 V Model	24 V Model	12 V Model	24 V Model
< 25 °C	+ 0.027 V / °C	+ 0.054 V / °C	+ 0.021 V / °C	+ 0.042 V / °C
25 °C	0 V	0 V	0 V	0 V
> 25 °C	- 0.027 V / °C	- 0.054 V / °C	- 0.021 V / °C	- 0.042 V / °C

When battery sensor is not in used, you can also manually set the battery temperature. There are three manual battery temperature settings on the unit ('Lo', 'nor' and 'hi'). See below for voltage adjustments for temperature compensation.

Temperature Setting	Recommended for Battery Temperature	Battery Type	Voltage adjustment from 25°C normal setting	
			12 V model	24 V model
Low (Lo)	<5°C (41°F)	GEL, Flooded	+ 0.675 V	+ 1.350 V
		AGM	+ 0.525 V	+ 1.050 V
Normal (nor)	>5°C and <30°C (>41°F and <86°F)	GEL, Flooded	0 V	0 V
		AGM	0 V	0 V
High (Hi)	>30°C (86°F)	GEL, Flooded	- 0.27 V	- 0.54V
		AGM	- 0.21 V	- 0.42V

**Procedure to set or view charger setting:**

Follow the procedure or sequence in Appendix A1 and A2 to set or view the charger setting.

**GEL, AGM or Flooded battery type:**

Parameters below are required for setting:

- Battery type (**GEL, AGM, Flooded**)
- Maximum Current setting (see table below)
- Absorption to float stage current setting (see table below)
- Charging stage (3-stage , 2-stage)
- Battery temperature (low, normal, high temperature)

The following table shows the maximum available charging current and its related available Absorption to Float stage current.

Model	Maximum Current Setting	Absorption to Float Stage Current Setting
AC 1220	* 20A	* 1A / 2A / 4A
	15A	0.75A / 1.5A / 3A
	10A	0.5A / 1A / 2A
	5A	0.3A / 0.5A / 1A
AC 1240	* 40A	* 2A / 4A / 8A
	20A	1A / 2A / 4A
	10A	0.5A / 1A / 2A
	5A	0.3A / 0.5A / 1A
AC 1260	* 60A	* 3A / 6A / 12A
	40A	2A / 4A / 8A
	20A	1A / 2A / 4A
	5A	0.3A / 0.5A / 1A
AC 2430	* 30A	1.5A / 3A / 6A
	20A	1A / 2A / 4A
	10A	0.5A / 1A / 2A
	5A	0.3 / 0.5A / 1A

Note: \* Recommended setting (Factory Default Setting)

**Lithium battery type:**

Parameters below are required for setting:

- Charging Voltage (13.9-14.4V for 12V model and 27.8-28.8V for 24V model)
- Maximum Charging Current (see table below)
- Termination Charging Current (current to define when the charging process will terminate)

The following table shows the available charging voltage, maximum charging current, and the available termination charging current.

Model	Charging Voltage	Maximum Charging Current	Termination Charging Current
AC1220	13.9 – 14.4 V	* 20A	* 1A / 2A / 4A
		15A	0.75A / 1.5A / 3A
		10A	0.5A / 1A / 2A
		5A	0.3A / 0.5A / 1A
AC1240	13.9 – 14.4 V	* 40A	* 2A / 4A / 8A
		20A	1A / 2A / 4A
		10A	0.5A / 1A / 2A
		5A	0.3A / 0.5A / 1A
AC1260	13.9 – 14.4 V	* 60A	* 3A / 6A / 12A
		40A	2A / 4A / 8A
		20A	1A / 2A / 4A
		5A	0.3A / 0.5A / 1A
AC2430	27.8 – 28.8 V	* 30A	1.5A / 3A / 6A
		20A	1A / 2A / 4A
		10A	0.5A / 1A / 2A
		5A	0.3A / 0.5A / 1A

**Program (Power Supply) type:**

Parameters below are required for setting:

- Supply Voltage 13.3, 13.5, 13.7 Vdc
- Maximum available current (see table)

The following table shows the programed voltage and the maximum current setting.

Model	Program Output Voltage Setting	Max. Current
AC1220	13.3V/13.5V/13.7V	20A/15A/10A/5A
AC1240	13.3V/13.5V/13.7V	40A/20A/10A/5A
AC1260	13.3V/13.5V/13.7V	60A/40A/20A/5A
AC2430	26.6V/27.0V/27.4V	30A/20A/10A/5A

### Procedure to Equalize Flooded Battery:

**DANGER:** Explosion Hazard. The battery generates explosive gases during equalization.

Follow all the battery safety precautions listed in the manual.

**DANGER:** Explosion Hazard and Risk of Battery damage. When using the equalization mode, the user has to be sure the battery connected to the channel is a flooded battery type.

Equalizing a non-flooded battery may overcharge the battery and may cause the battery to explode.

**CAUTION:** Risk of Battery and Equipment damage. Only the Flooded lead-acid can be equalized. Consult your battery manufacturer or read the battery manual when you try to equalize your batteries. Disconnect any DC load connected to the battery, as during equalize mode, the charger will produce 16V on 12V model, or 32V on 24V model to the batteries. You must monitor the battery specific gravity throughout the equalization process to determine the end of the equalizing cycle.

Before setting the equalization mode on the specific channel, please be sure the channel chosen for battery equalization is for a flooded battery type. When the battery equalization is started, the charger will automatically fully charge the selected channel first and follow with 1 hr of equalization. Check the battery electrolyte level during the equalization period. If necessary, refill with distilled water only. All cells should have similar electrolyte levels. If distilled water is added, batteries must undergo a complete charge cycle. The charger cannot determine when to terminate the equalization of the battery. A one hour time-out is set and this is used as a safety feature to require the user to continually re-activate it as necessary after checking batteries manually.

During equalization mode the other two banks are disabled.

Use the following procedure to setup the charger for battery equalization.

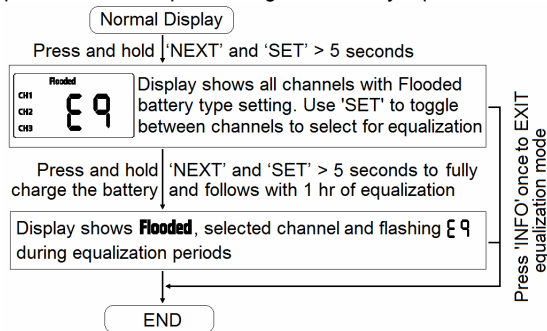

### Understanding the Silent Mode Function

The charger also comes with another unique '**Silent**' Mode function that will stop the internal fan operation.

**Tips:** Use this function during night time or when a quiet environment is needed. Please also note that the charging time will increase in this mode because the charger is not running at maximum power.

This function can switch to **ON** or **OFF** at any time during the charging period.

To set this function, press and hold '**SET**' key for 3 seconds to execute the '**Silent**' Mode. The '**Auto**' icon will show on the display.

To turn this function off, press and hold the '**SET**' function for 3 seconds to turn off '**Silent**' Mode. The '**Auto**' icon on the display will turn off and the charger current and the fan speed will return to normal.

The charger will also automatically depart **Silent** Mode after 12 hours from initial depress.

### Understanding the Protection Features

#### De-rating Charging Current:

When the charger senses the environmental temperature is above 50°C, the maximum charger current will de-rate to 1/2 of the value (A02 warning code will display). The charger

will recover automatically back to maximum charging current when the environmental temperature drops to below 45°C.

**Over Temperature Shutdown:**

When the charger senses the environmental temperature is above 60°C, the charger will shutdown. It will recover automatically when the environmental temperature drops to below 45°C.

**Battery Reverse Polarity:**

When a reverse polarity is connected to the battery bank, Fault Code E03 on display will appear. In some case, the user replaceable DC fuse located near the DC Output terminals may blow and Error code E08 will display.

**AC Input Voltage Protection:**

The charger will shutdown when it senses the AC input voltage is outside of the operating range. A fault code will display. The charger will recover automatically when it senses the AC input voltage has returned back to the normal operation range.

**Charging Dead Battery**

The charger is designed to charge batteries with terminal voltage greater than 2.5Vdc on 12V model and 5.0 Vdc on 24V model.

**Understanding the Error Codes**

Error codes will show on the display when either an internal fault such as *high internal temperature* or external fault like *AC input voltage out of range* is detected. The unit will shutdown.

Code	Condition	Corrective Action
A01	Temperature Sensor (BTS) is defective.	Check and or replace the sensor.
E01	Unit shutdown due to low AC Input (< 85 +/- 5Vac)	Check AC input source. The unit will automatically recover when the AC Input voltage return to > 108 +/- 5Vac
E02	Unit shutdown due to high AC Input (>270 +/- 5Vac)	Check AC input source. The unit will automatically recover when the AC Input voltage return to < 260 +/- 5Vac
E03	Battery is connected backwards	Check all battery connections
E04	Charger Internal temperature is too high and unit has shutdown. Unit will automatically recover when the unit cools down.	The ventilation of the unit is blocked or the environmental temperature is high. Reduce charging current or improve the ventilation near the unit.
E05	Not used.	
E06	High battery temperature >70 °C (158°C) is sensed by the BTS. The unit will shutdown. Unit will automatically recover when battery temperature has reduced to 60°C (140°F).	Check battery, charger setting and the environment the charger is in.
E07	Low battery temperature < -25°C (-13°F) is sensed by the BTS. The unit will shutdown. Unit will automatically recover when battery temperature reaches -20°C (-4°F).	It is not recommended to charge the battery at extreme low temperatures.
E08	DC Output fuses are brown.	Check battery connection and replace fuse with the same type and rating.
E09	Unit shutdown due to high battery voltage (> 17 Vdc on 12V model and >34 Vdc on 24V model). Unit will automatically recover when battery Voltage reduced to <16Vdc on 12V model or <32 Vdc on 24V model.	Check battery and charger setting. Check also if there is any other DC supply connected to the battery banks.



## 6. SPECIFICATIONS

	<b>AC1220</b>	<b>AC1240</b>	<b>AC1260</b>	<b>AC2430</b>
<b>Charger Output:</b>				
Output Current (Maximum)	20A	40A	60A	30A
Output Voltage Range:				
Charge	14.2 - 15.5 V			28.4 – 31.0 V
Float	13.4 - 13.8 V			26.8 – 27.6 V
Equalize	16.0 V			32.0 V
Charging Control	Three stages (Bulk/Absorption/Float)			
	Two stages (Bulk/Absorption)			
	Constant Power Supply (Program setting)			
DC Output Bank	Three			
Selectable Battery Type	<b>Gel, AGM, Flooded, Lithium</b> , Program			
Parasitic Current	< 2 mA			
<b>Charger Input:</b>				
AC Input Voltage (Nominal)	100, 120, 220, 230, 240 VAC			
AC Input Operating Range	90 - 265 VAC			
AC Input Frequency Range	47 - 63 Hz			
Power Consumption (Full Load)	350W	700W	1050W	1050W
Power Factor Correction	Yes			
Charger Efficiency	> 82%			
<b>Protection and Features:</b>				
Reverse Battery	Yes, unit shutdown			
Over Charge	Yes, unit shutdown			
Over Temperature	Yes, unit de-rated and shutdown			
Output Short Circuit	Yes, unit shutdown			
DC Fuse	2*15A, 32V	2*30A,32V	3*30A,32V	3*20A,32V
Cooling	Force air ventilation			
Temperature Setting	Hot, Normal, Cold (no sensor connected)			
Battery Temperature Sensor Port	RJ12 (optional battery temp. sensor use)			
Digital Display Port	RJ12 (optional display panel use)			
<b>Display:</b>				
LCD Display (with back lighting)	Charging status, Battery Voltage			
Warning and Fault Code	A01, E01-09			
<b>AC Input and DC Output Connection:</b>				
AC Input Connection	Hardwire or AC Cord			
DC Output Connection (POS)	Heavy Duty Studs (3 banks)			
DC Output Grounding (NEG)	Single Heavy Duty Common Ground Stud			
<b>Environmental and Operating Temperature:</b>				
Storage Range	-40° to 70° C (-40° to 158° F)			
Operating Range	-20° to 60° C (-4° to 140° F)			
Humidity	5-95%, RH non-condensing			
Ingress Protection	IP32			
<b>Based Unit Weight and Dimensions:</b>				
<b>AC1220</b>	5.3 lb., 11.6 x 8.1 x 3.4 inches (2.4 Kg, 295 x 206 x 86 mm)			
<b>AC1240</b>	5.7 lb., 11.6 x 8.1 x 3.4 inches (2.6 Kg, 295 x 206 x 86 mm)			
<b>AC1260</b>	8.8 lb., 14 x 8.1 x 3.8 inches (4.0 Kg, 356 x 206 x 99mm)			
<b>AC2430</b>	8.8 lb., 14 x 8.1 x 3.8 inches (4.0 Kg, 356 x 206 x 99mm)			
<b>Regulatory Compliance:</b>				
<i>Standards/Safety</i> (North America)	Approved to UL1236 including the marine supplement UL1564 CSA C22.2 107.2-01			
<i>Standards/Safety</i> (European Union)	CE marked for the low voltage directive 2006-95-EC Complying with EN60335-2-29 battery chargers Approved to IEC60529:2001, IP32 ingress protection level			
<i>Standards/EMC</i> (North America)	Class B according to FCC part15B and ANSI C63.4			
<i>Standards/EMC</i> (European Union)	CE marked for the EMC directive 2004-108-EC Complying with EN55014-1, EN55014-2, EN61000-3-2 and EN61000-3-3 (as equivalent IEC standards series)			

*Note: Specifications are subject to change without notices.*

### Accessories (optional):

Remote Digital Display	ACRM1201
Battery Temperature Sensor	BTS-10K
PC Interface & Software	ACPC01 (For monitoring and feature setting through PC USB port)

## 7. WARRANTY

### One Year Limited Warranty

The limited warranty program is the only one that applies to this unit, and it sets forth all the responsibilities of **KISAE**. There is no other warranty, other than those described herein. Any implied warranty of merchantability of fitness for a particular purpose on this unit is limited in duration to the duration of this warranty.

This unit is warranted, to the original purchaser only, to be free of defects in materials and workmanship for one year from the date of purchase without additional charge. The warranty does not extend to subsequent purchasers or users.

Manufacturer will not be responsible for any amount of damage in excess of the retail purchase price of the unit under any circumstances. Incidental and consequential damages are specifically excluded from coverage under this warranty.

This unit is not intended for commercial use. This warranty does not apply to damage to units from misuse or incorrect installation/connection. Misuse includes wiring or connecting to improper polarity power sources.

### RETURN/REPAIR POLICY:

If you are experiencing any problems with your unit, please contact our customer service department at [info@kisaetechnology.com](mailto:info@kisaetechnology.com) or phone 1 877 897-5778 before returning product to retail store. After speaking to a customer service representative, if products are deemed non-working or malfunctioning, the product may be returned to the purchasing store within 30 days of original purchase. Any defective unit that is returned to manufacturer within 30 days of the date of purchase will be replaced free of charge.

If such a unit is returned more than 30 days but less than one year from the purchase date, manufacturer will repair the unit or, at its option, replace it, free of charge. If the unit is repaired, new or reconditioned replacement parts may be used, at manufacturer's option. A unit may be replaced with a new or reconditioned unit of the same or comparable design. The repaired or replaced unit will then be warranted under these terms for the remainder of the warranty period. The customer is responsible for the shipping charges on all returned items.

### LIMITATIONS:

This warranty does not cover accessories, such as adapters and batteries, damage or defects result from normal wear and tear (including chips, scratches, abrasions, discoloration or fading due to usage or exposure to sunlight), accidents, damage during shipping to our service facility, alterations, unauthorized use or repair, neglect, misuse, abuse, failure to follow instructions for care and maintenance, fire and flood.

If your problem is not covered by his warranty, call our Customer Service Department at [info@kisaetechnology.com](mailto:info@kisaetechnology.com) or 1 877 897-5778 for general information if applicable.

# Appendix A1

Press and hold **Info** button for 3 seconds to enter the **Charger Function Setting Menu**

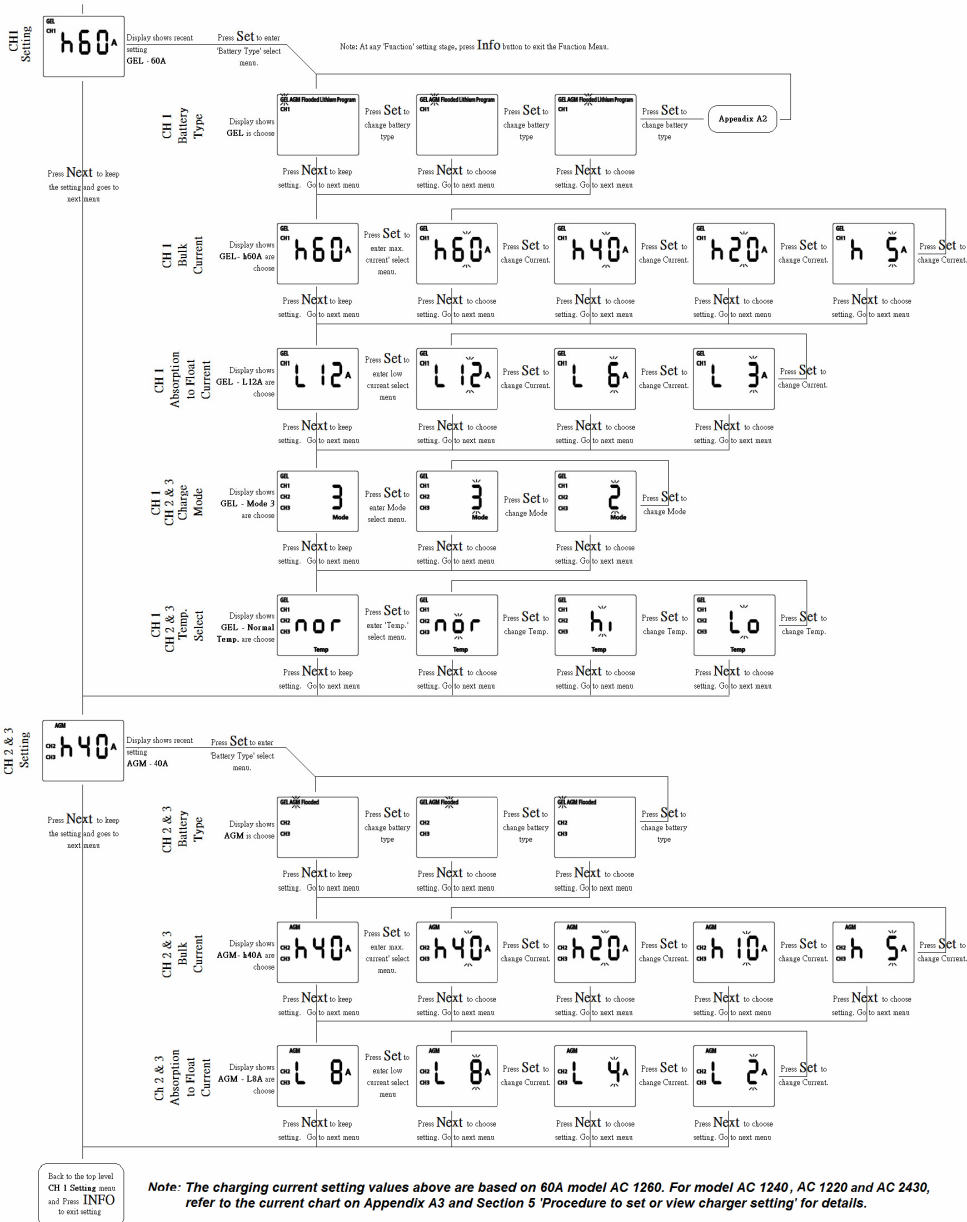

Back to the top level CH 1 Setting menu and Press **INFO** to exit setting

**Note:** The charging current setting values above are based on 60A model AC 1260. For model AC 1240, AC 1220 and AC 2430, refer to the current chart on Appendix A3 and Section 5 'Procedure to set or view charger setting' for details.

## Appendix A2

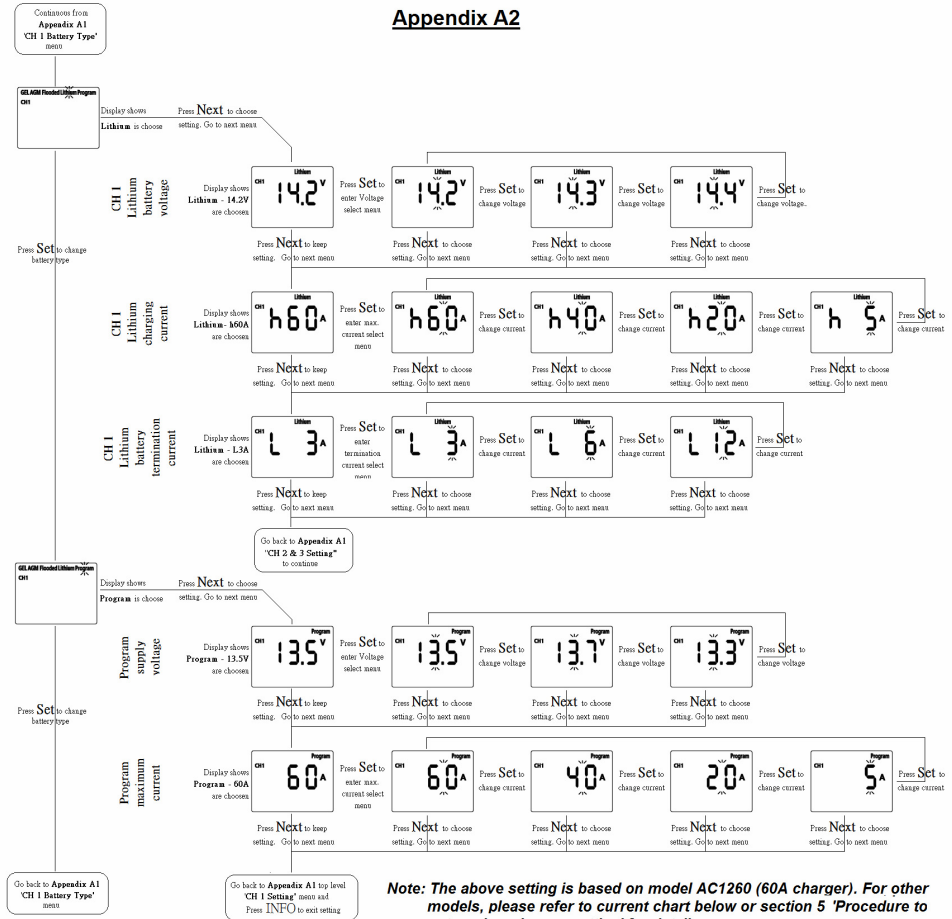

**Note: The above setting is based on model AC1260 (60A charger). For other models, please refer to current chart below or section 5 'Procedure to set or view charger setting' for details.**

### Different Battery Type Combination on CH 1 and CH 2&3

Battery Type Setting	Bulk / Absorption Voltage	Float Voltage
CH 1	CH 1	CH 1, 2 & 3
GEL*	GEL	14.2V (28.4V)
	AGM*	14.3V (28.6V)
	Flooded	14.4V (28.8V)
AGM	GEL	14.2V (28.4V)
	AGM	14.3V (28.6V)
	Flooded	14.4V (28.8V)
Flooded	GEL	14.2V (28.4V)
	AGM	14.3V (28.6V)
	Flooded	14.4V (28.8V)
Lithium	GEL	13.9 - 14.4V (27.9 - 28.8V)
	AGM	14.2V (28.4V)
	Flooded	14.3V (28.6V)
Program	Not available	Not Available

\* Factory default setting

### Charging Current Setting Chart

Model	Maximum Charging Current	Termination Charging Current	Maximum Float Current
AC1220	* 20A	* 1A / 2A / 4A	20A
	15A	0.75A / 1.5A / 3A	
	10A	0.5A / 1A / 2A	
	5A	0.3A / 0.5A / 1A	
AC1240	* 40A	* 2A / 4A / 8A	40A
	20A	1A / 2A / 4A	
	10A	0.5A / 1A / 2A	
	5A	0.3A / 0.5A / 1A	
AC1260	* 60A	* 3A / 6A / 12A	40A
	40A	2A / 4A / 8A	
	20A	1A / 2A / 4A	
	5A	0.3A / 0.5A / 1A	
AC2430	* 30A	* 1.5A / 3A / 6A	20A
	20A	1A / 2A / 4A	
	10A	0.5A / 1A / 2A	
	5A	0.3A / 0.5A / 1A	

## Appendix B

### Example Of Actual 40Amp, 3 Bank Test

