

Inverter-Charger

120V Series

12V-2000W-80A (BIC1220080)
12V-3000W-100A (BIC1230100)
24V-2000W-40A (BIC2420040)
24V-3000W-50A (BIC2430050)

230V Series

12V-2000W-80A (BIC1220080i)
12V-3000W-100A (BIC1230100i)
24V-2000W-40A (BIC2420040i)
24V-3000W-50A (BIC2430050i)

Owner's Manual

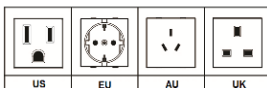

KISAESM

For safe and optimum performance, the Inverter-Charger must be used properly. Carefully read and follow all instructions and guidelines in this manual and give special attention to the **CAUTION** and **WARNING** statements.

PLEASE KEEP THIS MANUAL FOR FUTURE REFERENCE

Disclaimer

While every precaution has been taken to ensure the accuracy of the contents of this guide, **KISAE Technology** assumes no responsibility for errors or omissions. Note as well that specifications and product functionality may change without notice.

Important

Please be sure to read and save the entire manual before using your **KISAE Sinewave Inverter-Charger**. Misuse may result in damage to the unit and/or cause harm or serious injury. Read manual in its entirety before using the unit and save manual for future reference.

Model Numbers

120VAC Series :

BIC1220080 Inverter-Charger 12V / 2000W / 80A - 120VAC (NEMA 5-20)
BIC1230100 Inverter-Charger 12V / 3000W / 100A - 120VAC (NEMA 5-20)
BIC2420040 Inverter-Charger 12V / 2000W / 40A - 120VAC (NEMA 5-20)
BIC2430050 Inverter-Charger 12V / 3000W / 50A - 120VAC (NEMA 5-20)

230VAC Series :

BIC1220080i-EU Inverter-Charger 12V / 2000W / 80A - 230VAC (Schuko Socket - CEE 7/4)
BIC1220080i-UK Inverter-Charger 12V / 2000W / 80A - 230VAC (British Socket - BS1363)
BIC1220080i-AU Inverter-Charger 12V / 2000W / 80A - 230VAC (Australia Socket – NS/NZS3112)
BIC1230100i-EU Inverter-Charger 12V / 3000W / 100A - 230VAC (Schuko Socket - CEE 7/4)
BIC1230100i-UK Inverter-Charger 12V / 3000W / 100A - 230VAC (British Socket - BS1363)
BIC1230100i-AU Inverter-Charger 12V / 3000W / 100A - 230VAC (Australia Socket – NS/NZS3112)
BIC2420040i-EU Inverter-Charger 24V / 2000W / 40A - 230VAC (Schuko Socket - CEE 7/4)
BIC2420040i-UK Inverter-Charger 24V / 2000W / 40A - 230VAC (British Socket - BS1363)
BIC2420040i-AU Inverter-Charger 24V / 2000W / 40A - 230VAC (Australia Socket – NS/NZS3112)
BIC2430050i-EU Inverter-Charger 24V / 3000W / 40A - 230VAC (Schuko Socket - CEE 7/4)
BIC2430050i-UK Inverter-Charger 24V / 3000W / 40A - 230VAC (British Socket - BS1363)
BIC2430050i-AU Inverter-Charger 24V / 3000W / 40A - 230VAC (Australia Socket – NS/NZS3112)

Document Part Number

MUBIC Rev C1

Service Contact Information

Email: info@kisaetechnology.com
Phone : 1-877-897-5778
Web : www.kisaepower.com

WARNING: This product can expose you to chemicals, including Di (2-ethylhexyl) phthalate (DEHP) which is known to the State of California to cause cancer, birth defects or other reproductive harm. For more information, go to www.p65warnings.ca.gov

ADVERTENCIA Este producto puede exponerlo a productos químicos, incluidos Di (2-etilhexil) ftalato (DEHP) que el estado de California sabe que causa cáncer, defectos de nacimiento u otros daños reproductivos. Para obtener más información, vaya a www.p65warnings.ca.gov

IMPORTANT SAFETY INFORMATION

This section contains important safety information for the Sinewave Inverter-Charger. Before using the unit, READ ALL instructions and cautionary markings on or provided with the unit, and all appropriate sections of this guide.

The Sinewave Inverter-Charger contains no user-serviceable parts. See Warranty section for how to handle product issues.

DANGER: Fire and/or Chemical Burn Hazard

- Do not cover or obstruct any air vent openings and/or install in a zero-clearance compartment.

DANGER: Failure to follow these instructions can result in death or serious injury

- When working with electrical equipment or lead-acid batteries, have someone nearby in case of an emergency.
- Study and follow all the battery manufacturer's specific precautions when installing, using and servicing the battery connected to the inverter.
- Wear eye protection and gloves.
- Avoid touching your eyes while using this unit.
- Keep fresh water and soap on hand in the event battery acid comes in contact with eyes. If this occurs, cleanse right away with soap and water for a minimum of 15 minutes and seek medical attention.
- Batteries produce explosive gases. **DO NOT** smoke or have an open spark or fire near the system.
- Keep unit away from moist or damp areas.
- Avoid dropping any metal tool or object on the battery. Doing so could create a spark or short circuit which goes through the battery or another electrical tool that may create an explosion.

WARNING: Shock Hazard. Keep away from children!

- Avoid moisture. Never expose unit to snow, water, etc.
- Unit provides high voltage AC; treat the AC output socket the same as regular wall AC sockets at home.

WARNING: Explosion hazard!

- DO NOT install the unit near flammable fumes or gases (such as propane tanks or large engines).
- AVOID covering the ventilation openings. Always operate unit in an open area.
- Prolonged exposure to high heat or freezing temperatures will decrease the working life of the unit.
- DO NOT connect AC power sources like utility power or generator to the AC outputs of the unit. It will damage the unit and may cause fire. Feeding AC to the AC output of the unit is not covered by warranty.
- The **12V DC** unit is designed for use on **12V House Battery System** only. Use on a higher house battery system will damage the unit and lead to unit explosion.
- The **24V DC** unit is designed for use on **24V House Battery System** only. Use on a lower house battery system will damage the unit and lead to battery explosion.

FCC and EMC INFORMATION

This equipment has been tested and found to comply with the limits for a Class B digital device, pursuant to part 15 of the FCC Rules (for 120V models) and comply with the CE EMC Standard on 230V models. These limits are designed to provide reasonable protection against harmful interference in a residential installation. This equipment generates, uses, and can radiate radio frequency energy and, if not installed and used in accordance with the instructions, may cause harmful interference to radio communications. However, there is no guarantee that interference will not occur in a particular installation. If this equipment does cause harmful interference to radio or television reception, which can be determined by turning the equipment off and on, the user is encouraged to try to correct the interference by one or more of the following measures:

- Re-orient or relocate the receiving antenna.
- Increase the separation between the equipment and the receiver.
- Consult the dealer or an experienced radio/TV technician for help.

LIMITATIONS ON USE

Do not use in connection with life support systems or other medical equipment or devices.

Table of Contents

1.	INTRODUCTION	6
2.	PRODUCT DESCRIPTION.....	6
3.	UNDERSTANDING THE UNIT	7
4.	INSTALLING THE UNIT	11
5.	UNIT OPERATION	14
6.	TROUBLESHOOTING	28
7.	SPECIFICATIONS	29
8.	WARRANTY.....	31

1. INTRODUCTION

Thank you for purchasing the **KISAE Sinewave Inverter-Charger**. With our state of the art, easy to use design, this product will offer you reliable service by providing True Sinewave AC power for your home, cabin, boat, RV or trailer and recharge your battery automatically when utility AC is available. The Sinewave Inverter-Charger can run many AC-powered appliances when you need AC power anywhere. The multi-stage battery charger will charge different types of batteries. The built-in transfer switch will automatically switch the load to the battery power when the utility power is interrupted. This manual will explain how to use this unit safely and effectively. Please read and follow these instructions and precautions carefully.

2. PRODUCT DESCRIPTION

The Sinewave Inverter-Charger includes the items listed below.

- Inverter-Charger base unit
- Multi-Function Display
- 25' RJ12 Display Cable
- Owner's manual

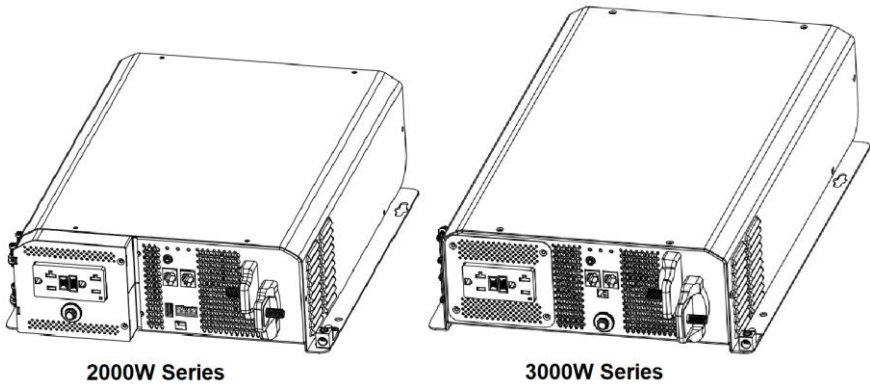

Series	Model No.	Rating			AC Output Types
		Inverter	Charger	By-Pass	
12V	BIC1220080	2000W	12V-80A	30A	<ul style="list-style-type: none"> • 20A GFCI • Hardwire
120VAC	BIC1230100	3000W	12V-100A	30A	
24V	BIC2420040	2000W	24V-40A	30A	
120VAC	BIC2430050	3000W	24V-50A	30A	<ul style="list-style-type: none"> • EU: Schuko-CEE 7/4) • UK: British- BS1363 • AU: Australia-NS/NZS3112 • Hardwire
12V	BIC1220080i	2000W	12V-80A	16A	
230VAC	BIC1230100i	3000W	12V-100A	16A	
24V	BIC2420040i	2000W	24V-40A	16A	
230VAC	BIC2430050i	3000W	24V-50A	16A	

3. UNDERSTANDING THE UNIT

WARNING: It is recommended that all wiring be done by a certified technician or electrician to ensure adherence to the applicable electrical safety wiring regulations and installation codes. Failure to follow these instructions can damage the unit and could also result in personal injury or loss of life.

CAUTION: Before beginning unit installation, please consider the following:

- The unit should be used or stored in an indoor area away from direct sunlight, heat, moisture or conductive contaminants.
- When placing the unit, allow a minimum of three inches of space around it for optimal ventilation.

Main Unit Front

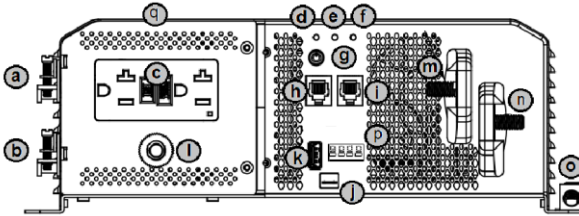

2000W Series

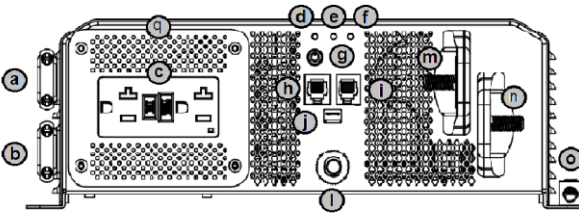

3000W Series

Item	Description
(a)	AC Input Cable Strain Relief
(b)	AC Output Hardwire Cable Strain Relief
(c)	AC Output Socket
(d)	Power Indicator
(e)	AC Output Indicator
(f)	Status Indicator
(g)	Power button
(h)	Display Port
(i)	Battery Temperature Sensor Port
(j)	Ignition Start Port
(k)	Program Port
(l)	AC Output Socket Circuit Breaker
(m)	DC Negative Stud
(n)	DC Positive Stud
(o)	Chassis Ground Connector
(p)	CAN BUS Port
(q)	AC Input / Output Wiring Compartment

Main Unit Rear

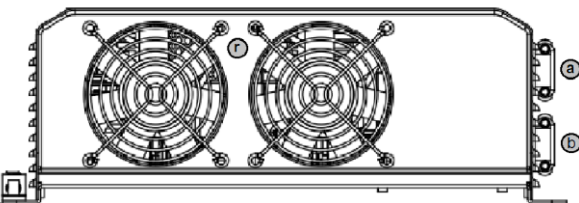

Item	Description
(a)	AC Input Cable Strain Relief
(b)	AC Output Hardwire Cable Strain Relief
(r)	Fans and Fan Guards

Multi-Function Display

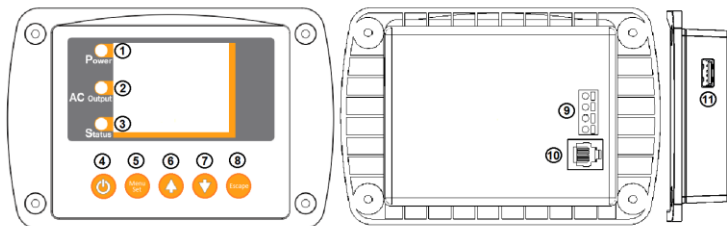

Item	Description
(1)	Power indicator
(2)	AC Output indicator
(3)	Status indicator
(4)	Power button
(5)	Manual button
(6)	Up button
(7)	Down button
(8)	Escape button
(9)	CAN BUS interface connector
(10)	Display Panel socket
(11)	Program port

Typical Wiring Block Diagram of Inverter-Charger:

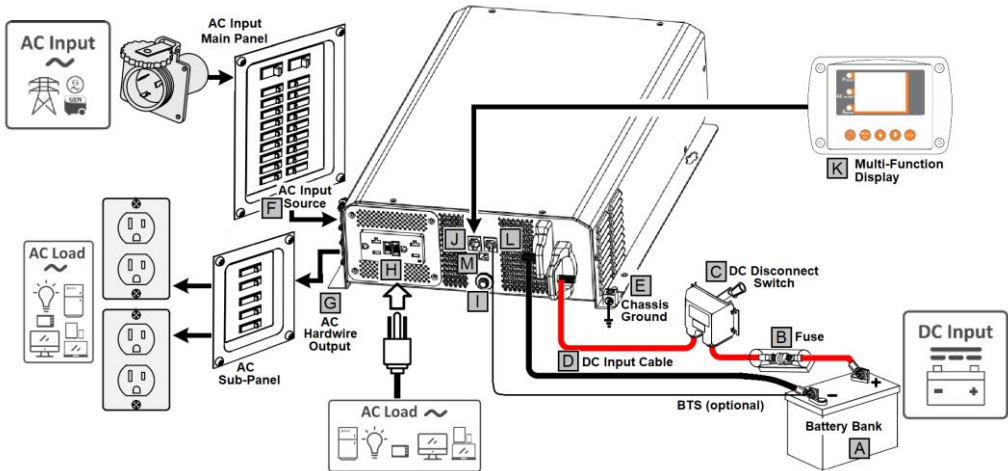

A Battery Bank

- The use of deep cycle battery is highly recommended for power inverter application
- For battery size, you need to identify how much and for how long the inverter has to provide AC power to the loads (based on Amps x hour energy consumption). It is recommended to purchase as much battery capacity as possible.

AC Load	Estimated run time on 12V Battery bank on 12V Input Models		Estimated run time on 24V Battery bank on 24V Input Models	
	12V/120AH	12V/240AH	24V/60AH	24V/ 120AH
50 W	22 hrs.	44 hrs.	22 hrs.	44 hrs.
100 W	11.5 hrs.	23 hrs.	11.5 hrs.	23 hrs.
200 W	5 hrs.	11 hrs.	5 hrs.	11 hrs.
500 W	2 hrs.	4 hrs.	2 hrs.	4 hrs.
1000 W	49 mins	2 hrs.	49 mins	2 hrs.
1500 W	27 mins	1 hr.	27 mins	1 hr.
2000 W	15 mins	49 mins	15 mins	49 mins
2500 W	N.R.	37 mins	N.R.	37 mins
3000 W	N.R.	27 mins	N.R.	27 mins

N.R. - Not Recommended. Based on more than 2C discharged on battery capacity.
Estimated run times are for reference use only. Actual run times may vary on battery type used.

B DC Fuse or Circuit Breaker

- DC-rated fuse or DC-rated circuit breaker connected along the DC positive line is required.

Fuse/Circuit Breaker Rating	12V 2000W System	12V 3000W System	24V 2000W System	24V 3000W System
		300A _{dc}	400A _{dc}	150A _{dc}

- Based on the size of the Battery Bank, determine the overall short circuit current rating of the battery bank from the battery manufacturer. The fuse or circuit breaker has to be able to withstand the short circuit current that can be supplied by the battery bank.
- For battery banks with total capacity under 500Ah the most affordable ANL fuse type can be used. Otherwise use Class-T type.

C DC Disconnect Switch

- A DC Disconnect Switch connected along the DC positive line is recommended. The rating of the switch is with the same or higher rating of the selected fuse or circuit breaker. Use ignition protected switches when required by local codes.
- This switch is used to disconnect the positive of the battery bank to the unit's positive terminal during maintenance/repair service, when not in use, or when troubleshooting. It could also be an A/B/A+B/OFF type switch to select either one of the two or both (paralleling) battery banks (if available).

D DC Input Cable

- All DC Input Wires should be insulated multi-strand low resistance wires.
- The DC wires must be copper and with minimum 105°C rating.

Model	Thinnest DC Input Wires Gauge Used		
	≤ 5 feet (Recommended)	≤ 7.5 feet	≤ 10 feet
12V 2000W series	AWG # 2/0	AWG # 3/0	250 kcmil (MCM)
12V 3000W series	AWG # 4/0	300 kcmil (MCM)	400 kcmil (MCM)
24V 2000W series	AWG # 1/0	AWG # 2/0	AWG # 3/0
24V 3000W series	AWG # 2/0	AWG # 3/0	AWG # 4/0

The typically recommended wire length is limited to 5 feet or less for each of the positive and the negative. For longer wires, a proportionally thicker gauge is required to compensate for additional voltage drop

CAUTION: These guidelines assume you are using the DC supplied cable and fuse sizes recommended in this manual. The use of a thinner gauge in the DC wires may cause the inverter to trigger the under-voltage shut down under heavy load conditions. It may also melt the wire insulation and catch fire, resulting in death or serious injury. The choice of the wire gauge should also match or exceed the ampacity rating of the DC fuse and holder being used.

E Chassis Ground

DANGER: The unit chassis has to be grounded properly before use. Never operate the unit without proper grounding. Failure to do so will result in death or serious injury.

Model	Thinnest Wire Gauge Used	
	Recreation Vehicle	Marine
12V 2000W series	AWG # 8	AWG # 1/0
12V 3000W series		AWG # 3/0
24V 2000W series		AWG # 0/0
24V 3000W series		AWG # 1/0

- These guidelines assume you are using the DC supplied cable and fuse sizes recommended in this manual. If you are using different sizes, refer to the applicable installation code for the DC grounding detail.
- In marine applications, the main AC-DC ground bonding may require galvanic isolators to avoid galvanic corrosion. Check your local electrical codes (i.e. NEC, UL, ABYC...).

F AC Input Source

An AC source is usually grid power or an AC Generator. The acceptable AC Input voltage range and frequency are as shown:

Model	Acceptable AC Input Voltage Range	Acceptable AC Input Frequency Range
120VAC series	90 - 140 VAC	30 - 100 Hz
230VAC series	180 - 260 VAC	30 - 100 Hz

An automatic or manual AC source selector switch can be used to switch between the multiple sources of shore power to the unit. Usually, the AC Main Panel includes a main circuit breaker that serves as over-current protection and as a disconnect for the AC shore power supply line. Additional AC circuit breakers serve individual circuits and one of the AC circuit breakers will serve the unit. During By-Pass mode, the AC Input source will serve the AC Output Load and also the AC Input current for the charger when it is used to charge the battery.

Model	AC Input Circuit Breaker to serve the unit	AC Input Wire
120VAC series	30A (maximum)	#10 AWG (minimum)
230VAC series	16A (maximum)	#14 AWG (minimum)

- Follow the electrical and/or building code when you choose AC Branch Breaker and AC Input wire Size. Connect the unit to any AC Input Source
- Smaller size AC Input wire can be used when a lower amperage rated AC Input Circuit Breaker is used from upstream to feed the unit.

The unit is designed to accept non-Sinewave AC Input Source supplied by a generator.

G AC Hardwire Output

An AC Sub-Panel is recommended to incorporate an AC output circuit breaker and breakers for individual load circuits. Use the same wire size as used for the AC Input Wire.

H AC Output Socket and I AC Output Thermal Breaker:

A single AC Output socket is provided for direct AC output from the unit. An overcurrent protective device (thermal breaker) is connected in series with the AC Output Socket to avoid excessive current being drawn from it.

Model	AC Output Socket Type	AC Output Thermal Breaker
120VAC series	NEMA 5-20 GFCI	20A
230VAC series	EU: Schuko-CEE 7/4)	16A
	UK: British- BS1363	13A
	AU: Australia-NS/NZS3112	10A

Model	By-Pass Mode Current (Maximum)			Inverter Mode Current (Maximum)		
	Total AC Output	AC Output Hardwire	AC Output Socket	Total AC Output	AC Output Hardwire	AC Output Socket
2000W/120VAC	30A	30A	GFCI 20A*	16.7A	16.7A	GFCI 16.7A
3000W/120VAC	30A	30A	GFCI 20A*	25A	25A	GFCI 20A *
2000W/230VAC	16A	16A	EU: 16A*	8.7A	8.7A	EU: 8.7A**
			UK: 13A*			UK: 8.7A**
			AU: 10A*			AU: 8.7A**
3000W/230VAC	16A	16A	EU: 16A*	13A	13A	EU: 13A**
			UK: 13A*			UK: 13A**
			AU: 10A*			AU: 10A *

* Limited by AC Output Thermal Breaker connected in series with the AC Output Socket.
** Limited by Inverter maximum AC Output Current during inverter mode.

J Display Port

The port is used to connect to the Multi-Function Display of the unit.

K Multi-Function Display

The display is used to provide unit information and for unit setting.

L BTS Port

The port is used for connecting to the optional Battery Temperature Sensor. The thermistor installed inside the ring terminal is used to measure the battery terminal temperature and the unit will make compensation on battery charging voltage for battery charging.

M Ignition Start Port

The port is used for connecting to the ignition start signal from vehicles to control the operation of the inverter.

* **Program Port** (not shown in the wiring block diagram)

This USB port is for system firmware upgrade use only. This CANNOT be used for charging Smartphones or USB powered devices. Mis-used of this port can potentially damage the unit and is not covered by the warranty. This port is located on the side of the Multi-Function Display and an extra port that shares the same function is also located below the *Ignition Start Port* on the 2000W models.

* **CAN-BUS Port** (not shown in the wiring block diagram)

This is for unit communication through the CAN interface. Mis-used on this port can potentially damage the unit and is not covered by the warranty. This port is located at the back of the Multi-Function Display and an extra port that shares the same function is also located near the *Ignition Start Port* on the 2000W models.

4. INSTALLING THE UNIT

WARNING: Explosion hazard!

- DO NOT install the unit near flammable fumes or gases (such as propane tanks or large engines).
- AVOID covering the ventilation openings. Always operate unit in an open area.

Choosing the location:

The unit should only be installed in locations that meet the following requirements:

- Do not allow water or other fluids to drip or splash on the unit.
- Environment temperature should be between -4 °F and 104 °F (-20 °C and 40 °C)
- Allow at least three inches of clearance around the unit. The more clearance for ventilation around the unit, the better the performance.

Mounting the Unit:

- Choose an appropriate mounting location.
- The unit can be mounted in any direction.
- Use the mounting template below to mark the positions of the mounting screws.
- Drill the 4 mounting holes and place the unit in position and fasten the unit to the mounting surface.

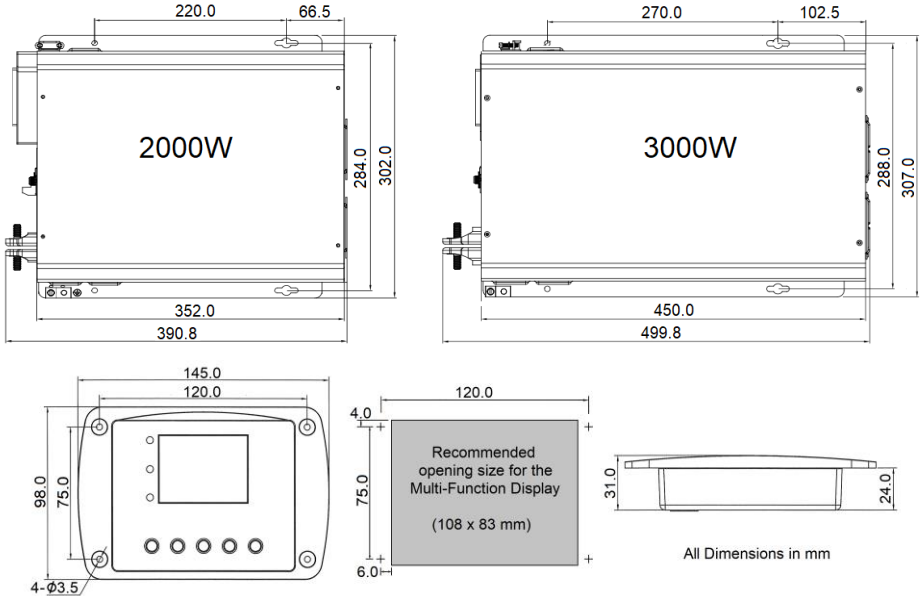

DC Input Connection:

WARNING: Electrical Shock Hazard

The unit 'On/Off' switch does not disconnect the DC power from the battery. Use the DC Disconnect Switch or disconnect the DC input cables to disconnect the DC power from the battery before working on any circuits connected to the unit. Failure to follow these instructions can result in death or serious injury.

CAUTION: Reversing the DC Input terminals will damage the unit and it cannot be repaired. Damage caused by reverse polarity connection is not covered by the warranty.

IMPORTANT: Field wiring DC terminals tightening torque 12-13 Nm

- Connect a negative DC input cable between the unit DC negative terminal and battery negative terminal.
- Make sure the Disconnect Switch is in the OFF position. Connect a positive DC input cable between the unit DC positive terminal and one terminal of the Disconnect Switch.
- Connect another DC input cable between the other terminals of the Disconnect Switch to one side of the terminal of the fuse holder or DC rated circuit breaker (OFF position).

- Connect another DC input cable between the other terminal of the fuse holder or DC rated circuit breaker to the battery positive terminal.
Note: For Marine application, either the DC fuse or DC rated circuit breaker needs to be installed within 7 inches (17.8cm) from the battery positive terminals.
- Install the selected fuse to the fuse holder.

Chassis DC Ground Connection:

- Connect the grounding wire to the unit’s Chassis DC Ground Lug located near the DC Input terminal and the other side of the cable to the common grounding point.
- For a Recreation Vehicle, the common ground point is usually the vehicle chassis or a dedicated DC ground bus.
- For Marine, the common ground point is usually the DC ground bus or engine negative bus.
Note: Do not use the Chassis DC Ground Lug for your AC Grounding, For AC Grounding, see AC Wiring instructions for more details.

AC Input and AC Output Hardwire Connections:

Warning: Before making any AC Input and AC Output Hardwire connection, please be sure the AC Input Source is not energized and the DC disconnect switch is switched OFF. Please double check the location of the AC input connector located inside the wiring compartment. Misconnecting to the AC output connector inside the same compartment will damage the unit and may cause fire.

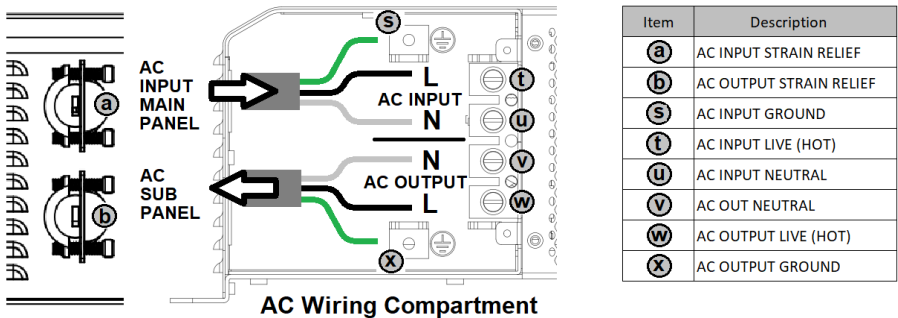

Remove the AC compartment cover by unscrewing the four screws located at the front of the AC compartment cover.

For AC Input Connections:

- Insert the AC Input cable through the AC Input Strain relief (a) on the unit.
- Connect the AC Main Panel AC Ground wire to the AC Input Ground terminal (S) on the unit. If a solid ground wire is used, the wire can be connected directly under the screw head. If a stranded ground wire is used, ring terminals must be used
- Connect the AC Main Panel AC Live or Hot wire to unit’s AC Input ‘L’ Live or ‘H’ Hot’ terminal (L).
- Connect the AC Main Panel AC Neutral wire to unit’s AC Input Neutral ‘N’ terminal (N).
- Tighten the strain relief to secure the AC Input wire.

For AC Output Hardwire Connections:

- Insert the AC Input cable through the AC Output Strain relief (b) on the unit.
- Connect the AC Sub-Panel AC Ground wire to the AC Output Ground terminal (X) on the unit. If a solid ground wire is used, the wire can be connected directly under the screw head. If a stranded ground wire is used, ring terminals must be used
- Connect the AC Sub-Panel AC Live or Hot wire to unit’s AC Output ‘L’ Live or ‘H’ Hot terminal (T).
- Connect the AC Sub-Panel AC Neutral wire to unit’s AC Output Neutral ‘N’ terminal (U).
- Tighten the strain relief to secure the AC Input wire.

Multi-Function Display Connection:

- Route the RJ12 cable from the unit to your desired location for the Multi-Function Display and connect one end of the cable to the main unit Display Port and the other end of the cable to the Display Panel socket located at the rear panel of the Multi-Function Display.

BTS (Battery Temperature Sensor) Connection (optional):

To provide more accuracy and precision on battery voltage charging against battery temperature, a BTS (sold separately) can be used. The BTS can also be used to terminate the charging cycle when it senses the temperature of the battery rise to above 60 °C or fall below 0 °C. See 'Understanding the Error Code' E19-E21 for more details. Use the following procedure to install the BTS.

- Connect the RJ12 end of the BTS cable to the BTS Port on the main unit.
- Install the ring terminal end of the BTS cable to the negative terminal of the battery bank.

Ignition Start Port Connection (optional):

The ignition start connection provides an inverter ON/OFF function through the Ignition Start Port. See more details on Understanding of Ignition Start On/Off function.

Quick Test on Unit after Installation:

- Connect a small AC load like a 40W light bulb to the AC Output of the unit.
- Switch DC disconnect switch to ON to provide battery power to the unit, then press and hold On/Off button on Main unit or 'Power' button on Display panel for 1 second to turn unit or Inverter ON
- The 'Status' LED on display will turn Amber indicating inverter is ON. AC Output indicator turns green indicating the AC is available at the AC Output terminal of the unit.
- Verify the 40W light bulb is ON.
- Switch ON the Main Circuit Breaker on the AC Input Panel.
- Switch ON the AC Input Circuit Breaker that provides AC Input power to the unit.
- If AC input source is available, the 'Status' LED amber will flash for about 10 seconds indicating the AC Input source is available. It will then turn to solid green or flashing green indicating the unit is running from the AC input source.
- Verify the 40W light bulb remains ON.
- The unit is successfully installed and functioning properly.

GFCI Monthly Testing (120VAC 2000W/3000W model if available)

- For units equipped with GFCI, the GFCI function is required to be tested monthly.
- To test the GFCI, turn unit ON either in By-Pass mode or battery power mode. Plug a small AC load (e.g. 40W light bulb) to the AC Output GFCI Socket.
- Check that the AC load is ON.
- Press the '**TEST**' button to trip the GFCI protection. A clicking sound should be observed. Check that the AC load is turned off. The unit will show the "E13" ("AC Output GFCI tripped") error code as long as the Load Sense ("LdS") feature is set to Off.
- Press the '**RESET**' button until hearing a click to reset the GFCI outlet.
- Check that the AC load is back ON again.

*Note: Be aware that a tripped GFCI outlet **cannot** be reset with the unit operating in Battery Power Mode and the Load Sense setting activated.*

How to Reset the GFCI outlet when tripped (120VAC 2000W/3000W model if available):

When Utility AC Input Source is available:

- Unplug all the AC loads from the unit's GFCI outlet.
- Press the '**RESET**' button until hearing a click to reset the GFCI socket.
- Plug in the AC Loads and verify the AC Load is ON.

When Utility AC Input Source is not available:

- Unplug all the AC loads from the unit's GFCI outlet.
- Turns unit On and be sure the unit is running in Battery Power Mode.
- Check / Set the Load Sense ("LdS") setting to off.
- Press the '**RESET**' button until hearing a click to reset the GFCI socket.
- Plug in the AC Loads and verify the AC Load is ON.

*Note 1: Be aware that a tripped GFCI outlet can only be **Reset** when there is a continuous AC Input supplying to the GFCI Socket.*

5. UNIT OPERATION

The unit is preset with factory default settings and will fulfill the basic needs for inverter-charger operation. The display is used to provide information about the unit status and the unit function can be customized through the Display.

Once the unit function is customized, the display can be removed if desired, as the unit can run without it.

Understanding the Indicator/Push Button/Unit Functions

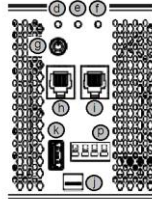
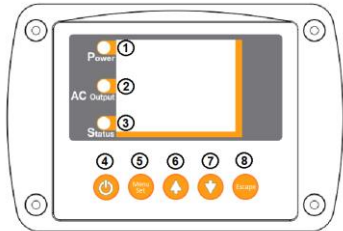

2000W

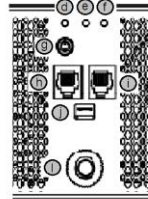

3000W

Item	Description
1	Power indicator
2	AC Output indicator
3	Status indicator
4	Power button
5	Manual button
6	Up button
7	Down button
8	Escape button
9	Display port
10	BTS port
11	Ignition Start port
12	Program port (2000W only)
13	CAN BUS port (2000W only)
14	AC Output Socket Circuit Breaker

Indicator	Status	Function
Power	ON	Unit is power ON
AC Output	ON	AC Output Switch is turned ON and AC is available at the Output Socket
	OFF	AC Output Switch is turned OFF and AC is not available at the Output Socket
Status	Green	AC Output is running from Utility
	Green (Flash)	AC Output is running from utility and battery charger is charging the battery
	Amber	AC Output is running from Inverter
	Amber (Flash)	Utility is detected and is under verification. AC Output is still running from Inverter and will switch to Utility in about 10 seconds.
	Red	Error/Warning occurs. Display will show Error or Warning code

Normal Operation

When unit is On, the Multi-Function display shows Battery Voltage 'V'.

Pressing any button will illuminate the backlighting of the display for about 10 seconds.

'Power' button (Same function as the green 'On/Off' push button on the main unit):

- To turn the inverter ON: press and hold until hearing the beep (in about 1 sec.). Display turns on and shows '-- -- --', all icons turn ON, followed by the revision levels of the main unit 'Rx.x' and then the Display revision levels 'rx.x' (where x = any number).
- To turn the inverter OFF: press and hold until hearing the beep (in about 1 sec.). Display turns off and the unit cannot be turned on again but after about 3 sec (when hearing the deactivation of the internal relays).

Note: When AC Input is available, this 'Power' button cannot be used to turn OFF the unit.

'Menu/Set' button:

- Press once to view unit setting on display. See more details on **Viewing and Change Unit Setting** section.

Δ and **∇** button:

- The **Δ** or **∇** button can be used to scroll through DC Current 'A', AC Output Power 'KW' and Battery Voltage 'V'.
- Press and hold **Δ** and **∇** buttons together for 2 seconds to show firmware revision numbers.

'Escape' button:

Press and hold for 5 seconds to turn OFF or ON the AC Output Switch (use this button as an AC Output ON/OFF function for the Output Socket).

Viewing and Change Unit Setting

- When unit is in normal operation mode, Press **'Menu/Set'** button once to view unit setting as listed on the **Unit Setting Function Chart**.
- The **Δ** or **∇** button can be used to scroll through each unit setting. If a particular setting needs to

be modified, press and hold the 'Menu/Set' button for 5 seconds and the set parameter will flash on the display. Use the Δ or ∇ button to scroll through the available settings. Once the desired setting is chosen, press and hold the 'Menu/Set' button until a beeping sound occur and the new setting is saved.

- Press 'Escape' button once to return back to **Normal Operation**. (If none of the button is triggered for about 5 seconds, display will also return back to Normal Operation.

Unit Setting Function Chart

Unit Setting	Display	Description and Available Setting
Inverter	INVT ABU	ON : Use as Inverter only. No By-Pass functions.
		ABU (Default): Auto Backup. Inverter automatically turns ON when AC Blackout.
		MbU : Manual Backup. When AC Blackout occurs, Inverter has to be manually turned ON by using the 'Power' button' on either the Display panel or the 'Power' button on the Main unit
		OFF : Inverter function is disabled. No AC backup when AC Blackout.
Load Sense	LdS OFF	OFF (Default): Continuous AC Output when inverter is ON
		10 : Continuous AC Output when inverter is ON and AC load is > 10W
		15 : Continuous AC Output when inverter is ON and AC load is > 15W
		20 : Continuous AC Output when inverter is ON and AC load is > 20W
		25 : Continuous AC Output when inverter is ON and AC load is > 25W
Battery Low Disconnect	bLd 10.5*	Battery Low Disconnect Voltage selectable ranges is 10.5 - 12.0V (0.1V steps) * (Default voltage is set to 10.5V*)
Battery Low Warning	bLR 11.0*	Battery Low Warning Voltage selectable ranges is 11.0 - 12.5V (0.1V step)* (Default voltage is set to 11.0V*)
Battery Low Recovery	bLR 12.0*	Battery Low Recovery Voltage selectable ranges is 11.5 - 13.0V (0.1V step)* (Default voltage is set to 12.0V*)
Audible Buzzer	ALM ON	ON (Default): Buzzer is enabled. Unit buzzes when Warning or Error occurs.
		OFF : Buzzer is disabled. Unit does not buzz when Warning and Error occur.
AC Charger	CHG ON	ON (Default): AC Charger is enabled. Charge battery when AC Input is available. OFF : AC Charger is disabled. No battery charging when AC Input is available.
Battery Type	BAT GEL	GEL (Default): GEL Battery, default Bulk Charge/Float Voltage is 14.2V/13.8V*
		AGM : AGM Battery, default Bulk Charge/Float Voltage is 14.3V/13.4V*
		FLo : Flooded Battery, default Bulk Charge/Float Voltage is 14.4V/13.5V*
		LI : Lithium Battery, default Bulk Charge/Float Voltage is 13.9V/13.5V*
		PGM : Program, default Bulk Charge/Float Voltage is 13.8V/13.2V*
		PSY : Power Supply Mode, Default Power Supply Voltage 13.8V*
Bulk Current	bUL 100	12V/3000W Models: Selectable Ranges 100A, 80A, 60A, 40A, 25A (Default 100A).
		12V/2000W Models: Selectable Ranges 80A, 60A, 40A, 20A, 10A (Default 80A).
		24V/3000W Models: Selectable Ranges 50A, 40A, 30A, 20A, 10A (Default 50A).
		24V/2000W Models: Selectable Ranges 40A, 30A, 20A, 10A, 5A (Default 40A).
Bulk/Absorption Voltage	AbS 14.2*	Bulk/Absorption voltage is based on the battery type chosen. All battery types have selectable ranges of 13.8 – 14.8V*. (Default on GEL Battery is 14.2V*)
Absorption to Float Current	AbS 10	12V/3000W Models: Selectable Range: 20A, 15A, 10A, 5A, 2A (Default 10A).
		12V/2000W Models: Selectable Range: 15A, 10A, 8A, 4A, 2A (Default 8A).
		24V/3000W Models: Selectable Range: 8A, 6A, 5A, 3A, 2A (Default 5A).
		24V/2000W Models: Selectable Range: 6A, 5A, 4A, 3A, 2A (Default 4A).
Float Voltage	FLo 13.8*	Float voltage is based on the battery type chosen. All battery types have selectable ranges of 13.0 – 14.0V*. (Default on GEL Battery is 13.8V*)
Recharge Voltage	rEC 12.8*	Battery Recharge Voltage Selectable Range: 12.8 to 14.0V (0.1V step)* (Default on GEL, AGM, Flooded, PGM battery setting is 12.8V* and Li setting is 13.2V).
Battery Temperature	bTM Nor	Hi : High > 35 °C
		Nor (Default): Normal 15 - 35°C
		Low : Low < 15°C
AC Input Source Circuit Breaker	Cbr 30	120 Vac Models: Range: 30A, 20A, 15A (Default 30A).
		230 Vac Models: Range: 4,6,8,10,12,13,14,16A, (Default 16A on EU, 13A on UK and AU).
Factory Default	MFd Flg	Select FLS to reset all settings to default.

* for **24 V Models (BIC2430050, BIC2420040, BIC2430050i, BIC2420040i)**, all the voltage values are doubled.

Understanding the Display Icons during Unit Operation

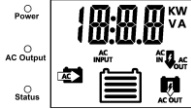





Icons		Meaning
		<u>Solid</u> : Unit is running in Battery Charger mode and is charging the battery.
		<u>Solid</u> : Unit is running in By-Pass mode. (The transfer switch is switched to AC Input Source). - AC Output power is running from AC Input Source. - AC Output is available at both the AC Output socket and the AC Output Hardwire terminal if AC Output switch is turned On (indicated by AC Output indicator located on the left side of the Display and also the Main unit being On). <i>Note: Press and hold the 'Escape' button on the Display panel for 5 seconds to toggle AC Output switch On/Off.</i>
		<u>Solid</u> : AC Input is available and is in the operating range.
		<u>Flashing</u> : AC Input is detected and is under verification before switching to By-Pass mode. This normally takes about 10 seconds.
		<u>Solid</u> : Unit is running in Battery Mode (The transfer switch is switched to Inverter) - AC Output power is running from the inverter - AC Output is available at both the AC Output socket and the AC Output Hardwire terminal if AC Output switch is turned On (indicated by AC Output indicator located on the left side of the Display and also the Main unit being On). <i>Note: Press and hold the 'Escape' button on the Display panel for 5 seconds to toggle AC Output switch On/Off.</i>
		Battery bar(s) in <u>solid</u> indicating the unit is running in Battery Mode. The bars show estimated remaining battery power. 4 <u>solid bars</u> : Battery is Full 3 <u>solid bars</u> : Battery capacity with 75% remaining 2 <u>solid bars</u> : Battery capacity with 50% remaining 1 <u>solid bar</u> : Battery capacity with 25% remaining <u>No bar</u> : Battery is empty. Inverter will shut down when it reaches under-voltage shutdown point. <i>Note: This indicator is for reference use only. It varies depending on battery health or type used.</i>
		Battery bar(s) with the last bar <u>flashing</u> indicates the unit is running in By-Pass mode and the battery charging process is in progress. The charging stages are indicated by the number of bars.
		4 bars in <u>solid</u> : indicates the battery is fully charged and it is in Float stage
		Top bars <u>flashing</u> : indicates the battery is in Absorption charging stage
		Second top bar <u>flashing</u> : indicates the battery is in Bulk charging stage and the battery is > 13.5V
		Second bottom bar <u>flashing</u> : indicates the battery is in Bulk charging stage and the battery is > 12.5V
		Bottom bar <u>flashing</u> : indicates the battery is in Bulk charging stage and the battery is > 11.5V
		<u>No bar</u> : indicates the battery is in Bulk charging stage and the battery is > 10.5V
	<u>Battery icon flashing</u> : indicates the battery is in Bulk charging stage and the battery is below 10.5V	
Display Character		Meaning
28 A	'A' icon On indicates the display shows battery discharge current (28A as shown)	
0.80 kW	'kW' icon on, it indicates the display shows AC Output power in kW (0.80kW = 800W as shown)	
12.8 V	'V' icon on, it indicates the display shows battery voltage in V (12.8V as shown)	
E01	Warning icon on, it indicates the display shows Error/Warning Code (E01 as shown, Battery Low Disconnected error)	
E9	Equalization on Flooded battery is in process. This function is available for use with Flooded battery type only. The display will also show the equalization voltage during the process. Follow the instruction provided by the battery manufacturer when performing the equalization process.	
R 1.0	Indicating the Main unit firmware revision (R:1.0 shown)	
r 1.0	Indicating the Display Panel firmware revision (r:1.0 shown)	

Exploring the Unit Settings

a) Inverter and Charger Functions





i) Automatic Backup with Battery Charger Function Enabled – Unit Default Setting ('INT' = 'ABU', 'CHG' = 'ON')

This is the most commonly used setting on the unit. The charger function is enabled and the Inverter is in standby condition when AC Input Source or Shore Power is available. The Inverter will automatically turn on when AC Input source or shore power is interrupted. This provides smooth, uninterrupted AC power to the load.

INT CHG	ABU ON	Automatic Backup with Battery Charger Function Enabled (Unit Default setting)
When AC Input Source or Shore Power is available, unit is running in By-Pass Mode . AC Output is getting the power from the AC Input Source or Shore Power. Charger is enabled and Inverter is in standby condition.		
 <ul style="list-style-type: none"> - Display shows battery voltage (14.2V), use Δ or ∇ button to see DC Current <u>charging</u> the battery, AC Input Power. - AC INPUT is On indicates AC Input Source is in use. - AC OUT is On indicates AC Output is getting the power from AC Input source. - AC is On indicates the charger is enabled and is charging the battery. -  icon indicates the charging stage of the battery. 		
<ul style="list-style-type: none"> - 'Power' indicator on indicates unit is On. - If 'AC Output' indicator is On, it indicates the AC Output Switch is turned On (AC is available at the output socket and the output hardwire terminal). - If 'AC Output' indicator is Off, it indicates the AC Output Switch is turned Off (AC is not available at the output socket and the output hardwire terminal). - Press and hold 'Escape' button for 5 seconds to toggle AC Output Switch On and Off. - If 'Status' indicator is solid green, it indicates battery is fully charged. - If 'Status' indicator is flashing green, it indicates battery charging is in progress. <p><i>Note: In By-Pass Mode, the 'Power' button function is disabled. It cannot be used to turn Off the unit.</i></p>		
When there is a <u>blackout</u> (AC Input Source or Shore Power is not available), unit is running in Inverter/Battery Mode . Unit will automatically switch to getting AC Power from the inverter. Charger is disabled.		
 <ul style="list-style-type: none"> - Display shows battery voltage (12.8V), use Δ or ∇ button to see DC Current <u>discharge</u> from battery, AC Output Power. - AC OUT is On indicates inverter is providing AC Power. -  icon indicates estimated battery capacity. 		
<ul style="list-style-type: none"> - 'Power' indicator on indicates unit is On. - If 'AC Output' indicator is On, it indicates AC Output Switch is turned On (AC is available at the output socket and the output hardwire terminal). - If 'AC Output' indicator is Off, it indicates AC Output Switch is turned Off (AC is not available at the output socket and the output hardwire terminal). - Press and hold 'Escape' button for 5 seconds to toggle AC Output Switch On and Off. - If 'Status' indicator is solid amber, it indicates inverter is running. - If 'Status' indicator changes to flashing amber, it indicates AC Input Source is detected and will switch back to By-Pass Mode shortly. <p><i>Note: In Inverter/Battery Mode, the 'Power' button can be used to temporarily turn the unit Off to save battery power if AC Output power is not required. When AC Input Source or Shore Power returns, unit will automatically turn On and run in By-Pass Mode again.</i></p>		













ii) Automatic Backup with Battery Charger Function Disabled – ('INT' = 'ABU', 'CHG' = 'OFF')

This is a setting when a second Battery Charging source is use and the unit's built-in AC Charger function is disabled at all times. Please note that a second battery charging source is required to charge the battery. The Inverter will automatically turn on when AC Input source or shore power is interrupted. This provides smooth, uninterrupted AC power to the load. The inverter is in standby condition.

INT	ABU	Automatic Backup with Battery Charger Function Disabled
CHG	OFF	
<p>When AC Input Source or Shore Power is available, unit is running in By-Pass Mode. AC Output is getting the power from the AC Input Source or Shore Power. Charger is disabled. Inverter is in standby condition.</p>		
	<ul style="list-style-type: none"> - Display shows battery voltage (12.5V), use Δ or ∇ button to see DC Current (always 0A because charger is disabled), AC Input Power. - AC INPUT is On indicates AC Input Source is in use. - AC OUT is On indicates AC Output is getting the power from AC Input source. -  icon indicates estimated battery capacity. <p><i>Note: When this setting is used, AC Charger is disabled. A separate Battery Charger or other battery charging source is required to charge the battery.</i></p>	
<p>Power</p> <p>AC Output</p> <p>Status</p>	<ul style="list-style-type: none"> - 'Power' indicator on indicates unit is On. - If 'AC Output' indicator is On, it indicates the AC Output Switch is turned On (AC is available at the output socket and the output hardwire terminal). - If 'AC Output' indicator is Off, it indicates the AC Output Switch is turned Off (AC is not available at the output socket and the output hardwire terminal). - Press and hold 'Escape' button for 5 seconds to toggle AC Output Switch On and Off. - 'Status' indicator is solid green indicates unit is running in By-Pass Mode. <p><i>Note: In By-Pass Mode, the 'Power' button function is disabled. It cannot be used to turn Off the unit.</i></p>	
<p>When there is a <u>blackout</u> (AC Input Source or Shore Power is not available), unit is running in Inverter/Battery Mode. Unit has automatically switched to getting AC Power from the inverter.</p>		
	<ul style="list-style-type: none"> - Display shows battery voltage (12.8V), use Δ or ∇ button to see DC Current <u>discharged</u> from battery, AC Output Power. - AC OUT is On indicates inverter is providing AC Power. -  icon indicates estimated battery capacity. 	
<p>Power</p> <p>AC Output</p> <p>Status</p>	<ul style="list-style-type: none"> - 'Power' indicator on indicates unit is On. - If 'AC Output' indicator is On, it indicates AC Output Switch is turned On (AC is available at the output socket and the output hardwire terminal). - If 'AC Output' indicator is Off, it indicates AC Output Switch is turned Off (AC is not available at the output socket and the output hardwire terminal). - Press and hold 'Escape' button for 5 seconds to toggle AC Output Switch On and Off. - If 'Status' indicator is solid amber, it indicates inverter is running. - If 'Status' indicator changes to flashing amber, it indicates AC Input Source is detected and will switch back to By-Pass Mode shortly. <p><i>Note: In Inverter/Battery Mode, the 'Power' button can be used to temporarily turn the unit Off to save battery power if AC Output power is not required. When AC Input Source or Shore Power returns, unit will automatically turn On and run in By-Pass Mode again.</i></p>	















iii) **Manual Backup with Battery Charger Function Enabled** – ('INT' = 'MBU', 'CHG' = 'ON')

This is another commonly used setting on the unit. The charger function is enabled when AC Input Source or Shore Power is available. When there is a blackout, the inverter will not turn On automatically. It requires the user to manually turn on the inverter function when needed.

INT CHG	MBU ON	Manual Backup with Battery Charger Function Enable	
When AC Input Source or Shore Power is available, unit is running in By-Pass Mode . AC Output is getting the power from the AC Input Source or Shore Power. Charger is enabled. Inverter is disabled.			
		<ul style="list-style-type: none"> - Display shows battery voltage (14.2V), use Δ or ∇ button to see DC Current <u>charging</u> the battery, AC Input Power. -  is On indicates AC Input Source is in use. -  is On indicates AC Output is getting the power from AC Input source. -  is On indicates the charger is enabled and is charging the battery. -  icon indicates the charging stage of the battery. 	
		<ul style="list-style-type: none"> - 'Power' indicator on indicates unit is On. - If 'AC Output' indicator is On, it indicates AC Output Switch is turned On (AC is available at the output socket and the output hardwire terminal). - If 'AC Output' indicator is Off, it indicates AC Output Switch is turned Off (AC is not available at the output socket and the output hardwire terminal). - Press and hold 'Escape' button for 5 seconds to toggle AC Output Switch On and Off. - If 'Status' indicator is solid green, it indicates battery is fully charged. - If 'Status' indicator is flashing green, it indicates battery charging is in progress. <p><i>Note: In By-Pass Mode, the 'Power' button function is disabled in this stage. It cannot be used to turn Off the unit.</i></p>	
When there is a blackout (AC Input Source or Shore Power is not available), unit will not provide AC Backup as Inverter is disabled. Display remains On for 10 seconds with the following appearance:			
		<ul style="list-style-type: none"> - Display shows battery voltage (12.6V), use Δ or ∇ button to see DC Current (always 0A because charger is Off), AC Input Power (always 0W because Inverter is disabled). -  icon indicates estimated battery capacity. <p><i>Note: Under this condition, Display and unit will turn Off after 10 seconds. At any time, if an AC Input Source is detected, unit will switch back to By-Pass Mode automatically in about 10 seconds. During the 10 second period, 'Power' indicator turns On and 'Status' indicator remains Off.</i></p>	
		<ul style="list-style-type: none"> - 'Power' indicator on indicates unit is On. - 'AC Output' indicator is Off (AC Output is not available due to the inverter being set to Manual Backup Mode – MBU). - 'Status' indicator is Off. 	
If AC Output is required during a blackout, press and hold the ' Power ' button for one second to manually turn On the inverter.			
		<ul style="list-style-type: none"> - Display shows battery voltage (12.8V), use Δ or ∇ button to see DC Current <u>discharged</u> from battery, AC Output Power. -  is on indicates inverter is providing AC Power. -  icon indicates estimated battery capacity. 	
		<ul style="list-style-type: none"> - 'Power' indicator on indicates unit is On. - If 'AC Output' indicator is On, it indicates AC Output Switch is turned On (AC is available at the output socket and the output hardwire terminal). - If 'AC Output' indicator is Off, it indicates AC Output Switch is turned Off (AC is not available at the output socket and the output hardwire terminal). - Press and hold 'Escape' button for 5 seconds to toggle AC Output Switch On and Off. - If 'Status' indicator is solid amber, it indicates inverter is running. - If 'Status' indicator changes to flashing amber, it indicates AC Input Source is detected and will switch back to By-Pass Mode shortly. <p><i>Note: The 'Power' button can be used to turn the unit Off if AC Output power is not required. When AC Input Source or Shore Power returns, unit will automatically turn On and run in By-Pass Mode again.</i></p>	





iv) Manual Backup with Battery Charger Function Disabled – ('INT' = 'MBU', 'CHG' = 'OFF')

When there is a blackout, the inverter will not turn On automatically. It requires the user to manually turn on the inverter function when needed. The unit's built-in AC Charger function is disabled at all times. Please note that a second battery charging source is required to charge the battery.

INT	MBU	Manual Backup with Battery Charger Function Disabled	
CHG	OFF		
When AC Input Source or Shore Power is available, unit is running in By-Pass Mode . AC Output is getting the power from the AC Input Source or Shore Power. Both Charger and Inverter are disabled.			
		<ul style="list-style-type: none"> - Display shows battery voltage (12.5V), use Δ or ∇ button to see DC Current (always 0A because charger is disabled), AC Input Power. - AC INPUT is on indicates AC Input Source is in use. - AC Output is on indicates AC Output is getting the power from AC Input source. -  icon indicates estimated battery capacity. <p><i>Note: When this setting is used, AC Charger is disabled. A separate Battery Charger or other battery charging source is required to charge the battery.</i></p>	
<ul style="list-style-type: none">  AC Output  Status  		<ul style="list-style-type: none"> - 'Power' indicator on indicates unit is On. - If 'AC Output' indicator is On, it indicates AC Output Switch is turned On (AC is available at the output socket and the output hardwire terminal). - If 'AC Output' indicator is Off, it indicates AC Output Switch is turned Off (AC is not available at the output socket and the output hardwire terminal). - Press and hold 'Escape' button for 5 seconds to toggle AC Output Switch On and Off. - 'Status' indicator is solid green indicates unit is running in By-Pass Mode. <p><i>Note: In By-Pass Mode, the 'Power' button function is disabled in this stage. It cannot be used to turn Off the unit.</i></p>	
When there is a blackout (AC Input Source or Shore Power is not available), unit will not provide AC Backup as Inverter is disabled. Display remains On for 10 seconds with the following appearance:			
		<ul style="list-style-type: none"> - Display shows battery voltage (12.6V), use Δ or ∇ button to see DC Current (always 0A because charger is Off), AC Input Power (always 0W because Inverter is disabled). -  icon indicates estimated battery capacity. <p><i>Note: Under this condition, Display and unit will turn Off after 10 seconds. At any time, if an AC Input Source is detected, unit will switch back to By-Pass Mode automatically in about 10 seconds. During the 10 second period, 'Power' indicator turns On and 'Status' indicator remains Off.</i></p>	
<ul style="list-style-type: none"> Power  AC Output  Status  		<ul style="list-style-type: none"> - 'Power' indicator on indicates unit is On. - 'AC Output' indicator is Off (AC Output is not available due to the inverter being set to Manual Backup Mode – MBU). - 'Status' indicator is Off 	
If AC Output is required during a blackout, press and hold the 'Power' button for one second to manually turn On the inverter.			
		<ul style="list-style-type: none"> - Display shows battery voltage (12.8V), use Δ or ∇ button to see DC Current discharged from battery, AC Output Power. - AC Inverter is on indicates inverter is providing AC Power. -  icon indicates estimated battery capacity. 	
<ul style="list-style-type: none"> Power  AC Output  Status  		<ul style="list-style-type: none"> - 'Power' indicator on indicates unit is On. - If 'AC Output' indicator is On, it indicates AC Output Switch is turned On (AC is available at the output socket and the output hardwire terminal). - If 'AC Output' indicator is Off, it indicates AC Output Switch is turned Off (AC is not available at the output socket and the output hardwire terminal). - Press and hold 'Escape' button for 5 seconds to toggle AC Output Switch On and Off. - If 'Status' indicator is solid amber, it indicates inverter is running. - If 'Status' indicator changes to flashing amber, it indicates AC Input Source is detected and will switch back to By-Pass Mode shortly. <p><i>Note: The 'Power' button can be used to turn the unit Off if AC Output power is not required. When AC Input Source or Shore Power returns, unit will automatically turn On and run in By-Pass Mode again.</i></p>	













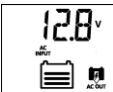

v) **No Backup with Battery Charger Function Enabled** – ('INT' = 'OFF', 'CHG' = 'ON')

The unit is used as a Battery Charger with AC Transfer Switch only. AC Output Power is available when AC Input Source or Shore Power is available. The Charger function is enabled when AC Input Source or Shore Power is available. Inverter function is disabled.









INT	OFF	No Backup with Battery Charger Function Enabled
CHG	ON	
When AC Input Source or Shore Power is available, unit is running in By-Pass Mode . AC Output is getting the power from the AC Input Source or Shore Power. Charger is enabled. Inverter is disabled.		
	<ul style="list-style-type: none"> - Display shows battery voltage (14.2V), use Δ or ∇ button to see DC Current charging the battery, AC Input Power. - AC INPUT is on indicates AC Input Source is in use. - AC IN AC OUT is on indicates AC Output is getting the power from AC Input source. - AC  is on indicates the charger is enabled and is charging the battery. -  icon indicates the charging stage of the battery. 	
<ul style="list-style-type: none"> Power AC Output Status 	<ul style="list-style-type: none"> - 'Power' indicator on indicates unit is On. - If 'AC Output' indicator is On, it indicates AC Output Switch is turned On (AC is available at the output socket and the output hardwire terminal). - If 'AC Output' indicator is Off, it indicates AC Output Switch is turned Off (AC is not available at the output socket and the output hardwire terminal). - Press and hold 'Escape' button for 5 seconds to toggle AC Output Switch On and Off. - If 'Status' indicator is solid green, it indicates battery is fully charged. - If 'Status' indicator is flashing green, it indicates battery charging is in progress. - <i>Note: In By-Pass Mode, the 'Power' button function is disabled. It cannot be used to turn Off the unit.</i> 	
When there is a blackout (AC Input Source or Shore Power is not available), unit will not provide AC Backup as Inverter is disabled. Display remains On for 10 seconds with the following appearance:		
	<ul style="list-style-type: none"> - Display shows battery voltage (12.6V), use Δ or ∇ button will see DC Current (always 0A because charger is Off), AC Input Power (always 0W because Inverter is disabled). -  icon indicates estimated battery capacity. - <i>Note: Under this condition, Display and unit will turn Off after 10 seconds.</i> - <i>At any time, if AC Input Source is detected, unit will switch back to By-Pass Mode automatically in about 10 seconds. During the 10 second period, 'Power' indicator turns On and 'Status' indicator remains Off.</i> 	
<ul style="list-style-type: none"> Power AC Output Status 	<ul style="list-style-type: none"> - 'Power' indicator on indicates unit is On. - 'AC Output' indicator is Off (AC Output is not available due to the inverter being set to OFF). - 'Status' indicator is Off. After 10 seconds, Display and unit will turn Off. - <i>Press and hold the 'Power' button for 1 second to turn On the Display to check the battery status.</i> 	

vi) Inverter only with No By-Pass or Battery Charger Function – ('INT' = 'ON', 'CHG' = 'ON or OFF')

This setting is specially designed so that the AC load connected to AC Output is always getting clean sinewave power from the inverter. Press and hold the '**Power**' button for one second to turn On or Off the Inverter. As the unit is set to Inverter only, it overrides the Charger On/OFF setting, meaning the charger is disabled in any condition. When this mode is used, a separate battery charging source is required to charge the battery.

INT	ON	Inverter Only: (Unit is running as inverter only, No By-Pass and Battery Charging Function)
CHG	OFF/ON	
With Inverter turned on and no AC Input Source or Shore Power is detected.		
		<ul style="list-style-type: none"> - Display shows battery voltage (12.8V), use Δ or ∇ button to see DC Current <u>discharged</u> from battery, AC Output Power. -  is on indicates inverter is providing AC Power. -  icon indicates estimated battery capacity.
<p>Power </p> <p>AC Output </p> <p>Status </p>		<ul style="list-style-type: none"> - 'Power' indicator on indicates Inverter function is On. - If 'AC Output' indicator is On, it indicates AC Output Switch is turned On (AC is available at the output socket and the output hardwire terminal). - If 'AC Output' indicator is Off, it indicates AC Output Switch is turned Off (AC is not available at the output socket and the output hardwire terminal). - Press and hold 'Escape' button for 5 seconds to toggle AC Output Switch On and Off. - 'Status' indicator is solid amber indicates inverter is running. <p><i>Note: The 'Power' button can be used to turn Inverter On and Off.</i></p>
With Inverter turned on with AC Input Source or Shore Power is detected.		
		<p>With AC Input Source detected, the  icon will be shown on the display but there is no inference to the AC Output. AC Output is still getting the power from the Inverter.</p> <ul style="list-style-type: none"> - Display shows battery voltage (12.8V), use Δ or ∇ button to see DC Current <u>discharged</u> from battery, AC Output Power. -  is on indicates AC Input Source is detected. -  is on indicates inverter is providing AC Power. -  icon indicates estimated battery capacity.
<p>Power </p> <p>AC Output </p> <p>Status </p>		<ul style="list-style-type: none"> - 'Power' indicator on indicates Inverter function is On. - If 'AC Output' indicator is On, it indicates AC Output Switch is turned On (AC is available at the output socket and the output hardwire terminal). - If 'AC Output' indicator is Off, it indicates AC Output Switch is turned Off (AC is not available at the output socket and the output hardwire terminal). - Press and hold 'Escape' button for 5 seconds to toggle AC Output Switch On and Off. - 'Status' indicator is solid amber indicates inverter is running. <p><i>Note: The 'Power' button can be used to turn Inverter On and Off.</i></p>

vii) AC By-Pass only, No Battery Charger and Inverter Function – ('INT' = 'OFF', 'CHG' = 'OFF')
 Unit is running in **By-Pass mode** only. When AC Input Source or Shore Power is available, AC Output is getting the power from the AC Input Source or Shore Power. Battery Charger function is disabled. When there is a blackout, unit will not provide AC Backup as the inverter function is also disabled. Please note that a second battery charging source is required to charge the battery when this mode is used.

INT	Off	AC Bypass only, Charger and Inverter Functions are disable
CHG	Off	
When AC Input Source or Shore Power is available, unit is running in By-Pass Mode . AC Output is getting the power from the AC Input Source or Shore Power.		
	<ul style="list-style-type: none"> - Display shows battery voltage (12.5V), use Δ or ∇ button to see DC Current (always 0A because charger is disable), AC Input Power. - AC INPUT is on indicates AC Input Source is in use. - AC OUT is on indicates AC Output is getting the power from AC Input source. -  icon indicates estimated battery capacity. <p><i>Note: When this setting is used, AC Charger is disabled. A separate Battery Charger or other battery charging source is required to charge the battery.</i></p>	
<ul style="list-style-type: none">  AC Output  	<ul style="list-style-type: none"> - 'Power' indicator on indicates unit is On. - If 'AC Output' indicator is On, it indicates AC Output Switch is turned On (AC is available at the output socket and the output hardwire terminal). - If 'AC Output' indicator is Off, it indicates AC Output Switch is turned Off (AC is not available at the output socket and the output hardwire terminal). - Press and hold 'Escape' button for 5 seconds to toggle AC Output Switch On and Off. - 'Status' indicator is solid green indicates unit is running in By-Pass Mode. <p><i>Note: In By-Pass Mode, the 'Power' button function is disabled. It cannot be used to turn Off the unit.</i></p>	
When there is a blackout (AC Input Source or Shore Power is not available), unit will not provide AC Backup as Inverter is disabled. Display remains On for 10 seconds with the following appearance:		
	<ul style="list-style-type: none"> - Display shows battery voltage (12.6V), use Δ or ∇ button will see DC Current (always 0A because charger is Off), AC Input Power (always 0W because Inverter is disabled). -  icon indicates estimated battery capacity. <p><i>Note: Under this condition, Display and unit will turn Off after 10 seconds. At any time, if the AC Input Source is detected, unit will switch back to By-Pass Mode automatically in about 10 seconds. During the 10 second period, 'Power' indicator turns On and 'Status' indicator remains Off.</i></p>	
<ul style="list-style-type: none">  AC Output  	<ul style="list-style-type: none"> - 'Power' indicator on indicates unit is On. - 'AC Output' indicator – Off (AC Output is not available due to the inverter being set to Off). - 'Status' indicator is Off <p>After 10 seconds, Display and unit will turn Off.</p> <p><i>Press and hold the 'Power' button for 1 second to turn On the display to check the battery status.</i></p> <p>If AC Input Source is detected, unit will switch back to By-Pass Mode automatically in about 10 seconds. During the 10 second period, 'Power' indicator turns On and 'Status' indicator remains Off.</p>	

b) Load Sense Function

Load Sense Mode	
LdS	This Load Sense function is only effective when the unit is running as inverter (Battery power) mode.
	'Off': Unit provides continuous AC Output power all the time.
	10: Load Sense power setting is set to 10W. Unit will provide continuous AC Output only when the AC load connected to the AC Output is >10W. AC Output will switch back to pulsing AC Output every few seconds when the AC Load connected is approximately 3W or less.
<ul style="list-style-type: none"> The Load Sense Power rating is available at power levels of 10W, 15W, 20W and 25W. This setting is designed to reduce battery power when the unit is running as inverter and the AC Load demand is small. Under this setting the GFCI tripping detection error code (E13) does not work, and a tripped GFCI cannot be reset when the function is in operation. See more details in "Reset the GFCI outlet" in section 4. 	

c) Battery Disconnect Function

Battery Under and Over Voltage Setting	
bLd	Battery Low Disconnect voltage has selectable range: 10.5 - 12.0V (0.1V steps) (Default 10.5V)
	The Battery Low Disconnect Voltage has to be with a minimum of 0.5V below the Battery Low Alarm (BLA) Voltage.
bLA	Battery Low Alarm Selectable range: 11.0 - 12.5V (0.1V step) (Default 11.0V)
	The Battery Low Alarm Voltage has to be with a minimum of 0.5V above the Battery Low Disconnect (BLd) Voltage and has to be with a minimum of 0.5V below the Battery Low Recovery (bLr) Voltage.
bLr	Battery Under Voltage Recovery Selectable range: 11.5 - 13.0V (0.1V step) (Default 12.0V)
	The Battery Low Recovery Voltage has to be with a minimum of 0.5V above the Battery Low Alarm (bLA) Voltage.
Battery Over Voltage Disconnect	16.5 V (Not User selectable)
Battery Over Voltage Recovery	16.0 V (Not User selectable)
<i>Note: For 24V systems, all the voltages are doubled.</i>	

d) Alarm Function

Alarm Setting	
AlM	Fault and warning audible alarm can be enabled (On -Default) or disabled (Off).

e) Charger Functions

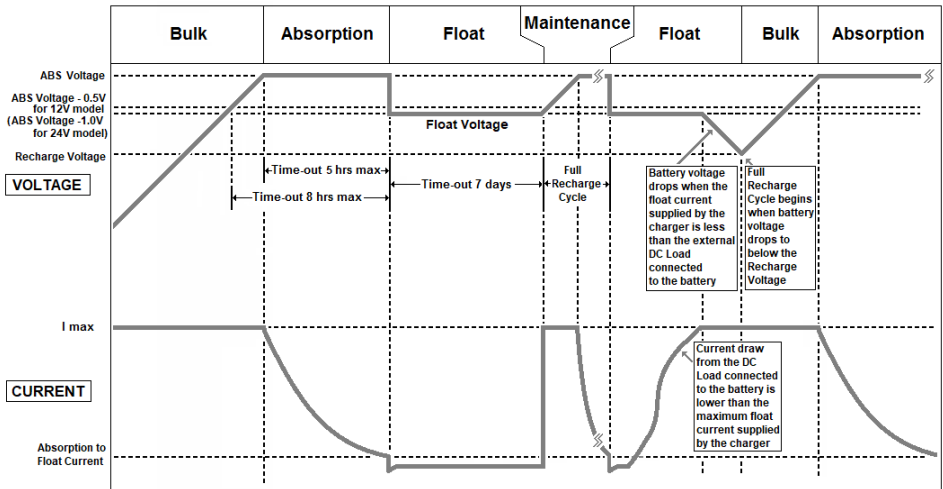

Battery Charging Cycle

Charging Voltage Setting: Bulk/Absorption (AbS), Float (FLO) and Recharge (rEC)			
Battery Type	Bulk Voltage (Default)	Float Voltage (Default)	Recharge Voltage (Default)
GEL	13.8-14.8V (14.2V)	13.0-14.0 (13.8V)	12.8-14.0 (12.8V)
Flooded	13.8-14.8 & 15.8V (14.4V)	13.0-14.0 (13.5V)	12.8-14.0 (12.8V)
AGM	13.8-14.8V (14.3V)	13.0-14.0 (13.4V)	12.8-14.0 (12.8V)
Lithium	13.8-14.8V (13.9V)	13.0-14.0 (13.5V)	12.8-14.0 (13.2V)
Program	13.8-14.8V (13.8V)	13.0-14.0 (13.2V)	12.8-14.0 (12.8V)
Power Supply	13.0-14.0V (13.8V)		

- Consult the battery manufacturer when choosing the bulk and float voltage for the battery bank.
- When selecting the Float voltage, it has to be with a minimum of 0.4V below Bulk Voltage setting.
- The Recharged Voltage determines the restart cycle of the battery bank. The charger will go through a full recharge cycle when the battery voltage drops to the Recharge Voltage set value. When selecting the Recharge Voltage, it has to be with a minimum of 0.4 below the Float Voltage setting.
- If Power Supply is chosen, the charger will provide a constant voltage to charge the battery bank.

Note: For 24V system, all voltages are doubled.

Charging Current Setting: Bulk Stage (bUL), Absorption to Float Stage (AbS)		
Model	Bulk Stage	Absorption to Float Stage
12V 3000W	100A, 80A, 60A, 40A, 25A (Default: 100A)	20A, 15A, 10A, 5A, 2A (Default: 10A)
12V 2000W	80A, 60A, 40A, 20A, 10A (Default: 80A)	15A, 10A, 8A, 4A, 2A (Default: 8A)
24V 3000W	50A, 40A, 30A, 20A, 10A (Default: 50A)	8A, 6A, 5A, 3A, 2A (Default: 5A)
24V 2000W	40A, 30A, 20A, 10A, 5A (Default: 40A)	6A, 5A, 4A, 3A, 2A (Default: 4A)

- Consult the battery manufacturer when choosing the Bulk Stage charging current of the battery bank. For a sealed lead acid battery, the rule of thumb for the maximum charging current is 1/5 of battery capacity.
- The Absorption to Float stage current determines the transition from Absorption stage to Float stage. If an external DC load is connected to the battery bank, a higher current setting is recommended to compensate for the extra current drawn from the external DC load.
- In order to avoid the tripping of the external AC Source Branch Breaker, when high powered AC loads are connected to the AC Output, the charging current will automatically be reduced so that the total AC Input current (AC Output Current + AC Charger Current) is maintained below the set values of the AC Input Circuit Breaker (Cbr). See more details in AC Source Circuit Breaker Function.



Note: When the battery charging process start, the unit will first measure the battery voltage, if it sense the battery voltage is below 9.5V, the charger current is automatically reduce to < 25A. It will resume back to the set charger current when the battery is charge to above 9.5V in 15 minutes. See more details on section Understanding on Unit Error code (E01 and E11).

Battery Temperature Setting 'bTM' (voltage adjustment from 25°C setting)
No Battery Temperature Sensor (BTS) installed
There are three settings (Low, Normal, High) available for battery temperature setting. <ul style="list-style-type: none"> Setting to 'Low' temperature will compensate the charging voltage by +0.675V on GEL and Flooded battery type and +0.525V on AGM battery type. Setting to 'Nor' will have no change to the selected charging voltage. Setting to 'Hi' temperature will compensate the charging voltage by -0.27V on GEL and Flooded battery type and -0.21V on AGM battery type.
Optional Battery Temperature Sensor (BTS) Installed (Part Number: BTS10K)
<ul style="list-style-type: none"> If the temperature measured by the BTS is below 25°C, the charging voltage will be compensated with +0.027V per °C on GEL and Flooded battery or +0.021V per °C on AGM battery. If the temperature measured by the BTS is above 25°C, the charging voltage will be compensated with -0.027V per °C on GEL and Flooded battery or -0.021V per °C on AGM battery.
There is no voltage adjustment compensation when battery type of Lithium, Program or Power Supply is selected.
<i>Note: For 24V systems, all the voltages are doubled.</i>

Flooded Battery Equalization Setting:
Equalization setting can only be set on Flooded batteries. Before the equalization begins, the unit will automatically fully charge the battery first, followed by one hour of equalization. Consult and follow the instruction provided by the battery manufacturer when performing the equalization process. <ul style="list-style-type: none"> Select 'Eq' under 'Bulk/Absorption Voltage' (AbS Voltage) setting. The unit will start a full flooded battery charging cycle first before the Equalization begins. The Equalization Voltage is set to 15.8V and current is limited to 1/10 of the set Bulk Stage Charging Current. Display will show 'Eq' and the battery voltage during the Equalization period. The unit cannot determine when to terminate the equalization of the battery. A one-hour timeout is set as a safety feature and requires the user to continually re-activate it as necessary after checking the batteries manually. To terminate the Equalization process, change and save the battery type to other types like AGM, GEL etc. and then change and save it back to the Flooded type battery.
<i>Note: For 24V systems, all the voltages are doubled.</i>

Battery Recharge Timer:
The charger will restart a full charging cycle automatically if the float stage is maintained for 7 days.

f) AC Source Circuit Breaker Function

AC Source Circuit Breaker Setting				
<table border="1"> <tr> <td></td> <td>120 Vac Models: Selectable Values: 30A, 20A, 15A (Default: 30A)</td> </tr> <tr> <td></td> <td>230 Vac Models: Selectable Values: 16, 14, 13, 12, 10, 8, 6, 4A (Default: 16A)</td> </tr> </table>		120 Vac Models: Selectable Values: 30A, 20A, 15A (Default: 30A)		230 Vac Models: Selectable Values: 16, 14, 13, 12, 10, 8, 6, 4A (Default: 16A)
	120 Vac Models: Selectable Values: 30A, 20A, 15A (Default: 30A)			
	230 Vac Models: Selectable Values: 16, 14, 13, 12, 10, 8, 6, 4A (Default: 16A)			
This setting limits the total AC current draw from the AC Source during the By-Pass Mode to avoid tripping the AC Source Branch Breaker. The selected value has to be the same or smaller than the rating of the AC Source Branch Breaker.				

g) Manufacturing Factory Default Function

Factory Default Setting
 Select 'Yes' to reset all the settings to the preset Factory Default settings.
<i>Note: The setting for battery type is GEL. If another battery type is used, select Yes to set all the parameter to factory default, then proceed to the battery type and make change to the new battery type.</i>

h) Understanding of Ignition Start ON/OFF function

When the Inverter setting "INT" is set to Manual Backup mode "MbU", providing +12V to the Ignition Start port will turn ON the inverter and removing the +12V will turn OFF the inverter.

Use of the 'Ignition Start' port located on the main unit overrides the 'Power' On/Off functions of both the Multi-Function Display and the 'Power' On/Off functions on the Main unit.

AC Load on Inverter

Although the Power Inverter can provide high surge power up to two times the rated output power, some high surge loads like air conditioners, sump-pumps, heavy-duty motors, etc. may still trigger the inverter protection system even though the load falls within the power rating of the inverter. A higher power Inverter-Charger is required for these appliances.

Understanding the Error Codes

Code	Condition	Corrective Action
E01 (Battery Mode)	No AC Output. Inverter shutdown due to low battery voltage.	Recharge the battery immediately and restart unit.
	<i>Note: E01 will shows for about 30 sec. After 30 sec,</i>	<i>Display will turns Off and unit will shutdown completely.</i>
E01 (By-Pass Mode)	- No battery is connected to the unit.	- Check the battery connection.
	- Battery voltage remains < 9.5V. A large portion of the charger current provided is used to maintain the DC load connected to the battery. E01 will turn OFF when the battery voltage is charged to > 9.5V	- Remove or turn off DC load connected to the battery to minimize the charging time to charge the battery to > 9.5V. If this condition is ignored, the charger will terminate the charging process (See note below).
	<i>Note: The charger current with battery voltage < 9.5V is limited to ~25A and there is a 15 minute timer to allow the charger to charge the battery to > 9.5V. If battery voltage remains < 9.5V after 15 minutes of charge, the charger will shutdown and show E11 (Bad battery).</i>	
E02	When unit is in Battery/Inverter mode, unit senses the battery voltage is too high and inverter has shutdown.	Check battery voltage or determine if any external charger is connected to the battery bank that leads to high battery voltage.
E03	When unit is in Battery/Inverter mode, AC output is overloaded or short-circuited and inverter has shutdown.	Check load connected to the output. Reduce load and restart the unit.
	<i>Note: E03 will shows for about 30 seconds. After 30 seconds,</i>	<i>Display will turns Off and unit will shutdown completely.</i>
E04	When unit is in Battery/Inverter mode, Internal temperature is too high and inverter has shutdown.	Turn unit off and wait for 15 minutes before restarting. Check if any object has blocked the airflow of the unit.
E05	When unit is in Battery/Inverter mode Input battery voltage is low and warning occurs.	Recharge battery as unit will shutdown shortly.
E06	When unit is in Battery/Inverter mode AC output load connected has been sensed high and is close to shutdown limit.	Reduce AC load. Note: E06 occurs when AC Output power is close to 1850W for 2000W units and 2800W for 3000W unit.
E07	When unit is in Batter/Inverter mode Internal temperature is high and is close to over-temperature shutdown limit.	Reduce load and check if any ventilation of the unit is blocked.
E10	When unit is in By-Pass mode, Battery Charging voltage too high.	Check battery setting. Check and any other DC power sources connected to the battery has high voltage.
E11	Bad Battery classification: E01 (By-Pass Mode) condition has not been solved. AC Charger has shutdown.	- Check corrective action in E01 (By-pass Mode) and restart the charging process by removing and reconnecting the AC Input Source.
	Other conditions leading to Bad Battery Classification: Battery Voltage remains below 2/5/9.5V after 2/5/15 minutes of charge.	- Check if there is any heavy DC load connected to the battery as stated in E01 (By-pass mode). Restart the charging process. - Change to a new battery.
E12	When unit is in By-Pass mode, Internal transfer switch temperature is high and shutdown occurs.	Reduce load and check if any ventilation of the unit is blocked.
E13	AC Output GFCI Tripped.	Reset the GFCI.
	<i>Note: This error function is not effective when Load Sense "LdS" function is in use.</i>	
E14	Display panel has communication error.	Check RJ12 cable connected between the main and Display panel.
E15	AC Back Feed to Unit AC Output.	Check AC Input and AC Output wiring.
E16	Internal Fault. Unit damage.	Consult Customer Service for assistance.
E17	AC Input Current withdrawn from the unit is close to the set AC Circuit Breaker (Cbr) rating.	Reduce AC load. Check the AC Circuit Breaker (Cbr) rating match with the external AC Input Source Branch Breaker rating.
E18	AC Input Current drawn by unit is beyond the current rating of the transfer switch. (30A for 120V model, 16A for 230V model). AC Output Switch is switched off.	Reduce AC Load connected to unit. Press and hold 'Escape' button for 5 seconds to reset AC Output Switch to provide AC Output from AC Input Source.
E19	Battery temperature sensed by BTS is > 60°C. Battery charging cycle terminates.	Cool down the battery. Battery charging cycle will automatically resume when the temperature drops to below 50 °C.
E20	Battery temperature sensed by BTS is > 55 °C and is close to battery temperature thermal shutdown	Check battery and environmental temperature or add ventilation to the battery compartment.
E21	Battery temperature sensed by BTS is < 0 °C. Battery charging cycle terminates.	Check battery and environmental temperature. The charging cycle will resume when temperature increases to > 5 °C.

6. TROUBLESHOOTING

To troubleshoot the unit, please note the error code displayed on the main unit and review “Understanding the Error Codes” in section 5.

Problem	Possible Cause/Condition	Solution
No AC Output at AC Output Socket	The thermal breaker on the unit is tripped	Reset the thermal breaker
	The AC Output switch is turned Off.	Press and hold the 'ESCAPE' button for 5 seconds to turn On the AC Output.
	With unit running from AC Input Source or shore power, the AC Input Source is available but is outside the acceptance range.	Check AC Input Source. Operating range of AC Input is 95 – 139Vac. Unit Start-up AC Voltage is higher than 99 Vac and below 132VAC.
	Unit is set to Inverter Off	Check unit 'Int' setting.
	Check Error code on display. Inverter may be overloaded.	Reduce AC load. Inverter may be overloaded.
	DC over-voltage, under-voltage, or other shutdown type errors in addition to overload.	Check battery voltage.
	For 120V model, GFCI may have tripped	Reset GFCI
Charger did not supply charging current	Check charger setting. Charger may be set to Off.	Set Charger function 'CHG' to On.
	Unit had determined the battery is bad. See also description in Error Code E01 (By-Pass Mode) and E11	Check battery and remove the DC load connected to the battery and restart the charger again
	Battery is with BTS installed and it senses the battery temperature is high (E19)	Check battery temperature or environmental temperature. Battery charging cycle will resume when the battery cools down to acceptable level. See Understanding the Error Codes for more details.
	Battery is with BTS installed and it senses the battery temperature is too low to accept charge (E21)	Check battery temperature or environment temperature. Battery charging cycle will resume when the battery temperature increase to acceptable temperature. See Understanding the Error Codes for more details.

7. SPECIFICATIONS

Note: Specifications are subject to change without notices.

12V Input Model

Specification	120VAC 12V Model		230VAC 12V Model	
	BIC1220080	BIC1230100	BIC1220080i	BIC1230100i
Running as Inverter				
AC Output Power	2000W	3000W	2000W	3000W
AC Output Current	16.6A	25A	8.7A	13.0A
AC Surge Power (Peak)	4000W	6000W	4000W	6000W
AC Output Voltage/Frequency	120 VAC / 60 Hz		230 VAC / 50Hz	
AC Output Waveform	Sinewave (<3% THD)			
Nominal DC Input Voltage	12.5 VDC			
No Load battery draw (Inverter Mode)	< 3.0 ADC		< 3.5 ADC	
DC Input Voltage operating range	10.5 – 16.5 VDC			
Under Voltage Alarm	11.0 - 12.5 VDC			
Under Voltage Alarm Recovery	11.5 - 13.0 VDC			
Under Voltage Shutdown	10.5 - 12.0 VDC			
Under Voltage Recovery	11.5 - 13.0 VDC			
Over Voltage Shutdown / Recovery	16.5 / 16.0 VDC			
AC Transfer Switch				
Transfer Time	< 30 ms			
Transfer Relay Rating	30A		16A	
AC Input Source Setting	15, 20, 30A		4, 6, 8, 10, 12,13,14, 16A	
AC Output Hardwire (max.)	30A		16A	
AC Output Socket (max.)	GFCI 20A		16A-EU,13A-UK,10A-AU	
Display				
Display Port	RJ12			
Inverter Mode	Battery Voltage, DC Current, AC Output Power			
Charger Mode	Charging Voltage, Charging Current, AC Input Power			
Running as Battery Charger				
Charging Voltage Range	13.8 - 14.8 VDC			
Float Voltage Range	13.0 - 14.0 VDC			
Recharge Voltage Range	12.8 - 14.0 VDC			
Bulk Charge Current Range	10 - 80 A	25 -100 A	10 - 80 A	25 -100 A
Absorption-Float Current Range	2 - 15 A	2 - 20 A	2 - 15 A	2 - 20 A
Battery Type	Gel, Flooded, AGM, Lithium, Program, Power Supply			
Charge Cycle Stages	Bulk / Absorption / Float / Recharge			
Maintenance Recharge Cycle	7 days			
Power Factor Correction	>95%			
Efficiency	>80%			

Safety and Environmental	120VAC Series	230VAC Series
Conformance	UL 458, CSA C22.2 No. 107.2-01	LVD: EN/IEC 62040-1, IEC 61558-2-16
EMI/EMC	FCC Part 15 Class B	EMC: EN/IEC 62040-2, Category C1
Agency Markings	cETLus	CE
Operating Temperature	0°C to 40°C (32°F to 104°F)	
Storage Temperature	-20°C to 60°C (-4°F to 140°F)	
Relative Humidity	5-90% non-condensing	
Operating Altitude	Up to 9,843ft (3000m) above sea level	
Weights and Dimensions		
Weights	2000W Series: 17.6 lbs. (8.0 kg) 3000W Series: 22.9 lbs. (10.4 kg)	
Dimensions	2000W Series: 15.4 x 11.9 x 4.2 inches (391 x 302 x 106 mm) 3000W Series: 19.7 x 12.1 x 4.2 inches (500 x 307 x 106 mm)	

24V Input Model

Specification	120VAC 24V Model		230VAC 24V Model	
	BIC2420040	BIC2430050	BIC2420040i	BIC2430050i
Running as Inverter				
AC Output Power	2000W	3000W	2000W	3000W
AC Output Current	16.6A	25A	8.7A	13.0A
AC Surge Power (Peak)	4000W	6000W	4000W	6000W
AC Output Voltage/Frequency	120 VAC / 60 Hz		230 VAC / 50Hz	
AC Output Waveform	Sinewave (<3% THD)			
Nominal DC Input Voltage	25.0 VDC			
No Load battery draw (Inverter Mode)	< 1.8 ADC			
DC Input Voltage operating range	21.0 - 33.0 VDC			
Under Voltage Alarm	22.0 - 25.0 VDC			
Under Voltage Alarm Recovery	23.0 - 26.0 VDC			
Under Voltage Shutdown	21.0 - 24.0 VDC			
Under Voltage Recovery	23.0 - 26.0 VDC			
Over Voltage Shutdown / Recovery	33.0 / 32.0 VDC			
AC Transfer Switch				
Transfer Time	< 30 ms			
Transfer Relay Rating	30A		16A	
AC Input Source Setting	15, 20, 30A		4, 6, 8, 10, 12,13,14, 16A	
AC Output Hardwire (max.)	30A		16A	
AC Output Socket (max.)	GFCI 20A		16A-EU,13A-UK,10A-AU	
Display				
Display Port	RJ12			
Inverter Mode	Battery Voltage, DC Current, AC Output Power			
Charger Mode	Charging Voltage, Charging Current, AC Input Power			
Running as Battery Charger				
Charging Voltage Range	27.6 - 29.6 VDC			
Float Voltage Range	26.0 - 28.0 VDC			
Bulk Charge Current Range	5 - 40 A	10 - 50 A	5 - 40 A	10 - 50 A
Absorption-Float Current Range	2 - 6 A	2 - 8 A	2 - 6 A	2 - 8 A
Battery Type	Gel, Flooded, AGM, Lithium, Program, Power Supply			
Charge Control	Bulk / Absorption / Float / Recharge			
Maintenance Recharge Cycle	7 days			
Power Factor Correction	>95%			
Efficiency	>80%			

Safety and Environmental	120VAC Series	230VAC Series
Conformance	UL 458, CSA C22.2 No. 107.2-01	LVD: EN/IEC 62040-1, IEC 61558-2-16
EMI/EMC	FCC Part 15 Class B	EMC: EN/IEC 62040-2, Category C1
Agency Markings	cETLus	CE
Operating Temperature	0°C to 40°C (32°F to 104°F)	
Storage Temperature	-20°C to 60°C (-4°F to 140°F)	
Relative Humidity	5-90% non-condensing	
Operating Altitude	Up to 9,843ft (3000m) above sea level	
Weights and Dimensions		
Weights	2000W Series: 17.6 lbs. (8.0 kg) 3000W Series: 22.9 lbs. (10.4 kg)	
Dimensions	2000W Series: 15.4 x 11.9 x 4.2 inches (391 x 302 x 106 mm) 3000W Series: 19.7 x 12.1 x 4.2 inches (500 x 307 x 106 mm)	

8. WARRANTY

One Year Limited Warranty

The limited warranty program is the only one that applies to this unit, and it sets forth all the responsibilities of KISAE. There is no other warranty, other than that described herein. Any implied warranty of merchantability of fitness for a particular purpose on this unit is limited in duration to the duration of this warranty.

This unit is warranted, to the original purchaser only, to be free of defects in materials and workmanship for one year from the date of purchase without additional charge. The warranty does not extend to subsequent purchasers or users.

Manufacturer will not be responsible for any amount of damage in excess of the retail purchase price of the unit under any circumstances. Incidental and consequential damages are specifically excluded from coverage under this warranty.

This unit is not intended for commercial use. This warranty does not apply to damage to units from misuse or incorrect installation/connection. Misuse includes wiring or connecting to improper polarity power sources.

RETURN/REPAIR POLICY

If you are experiencing any problems with your unit, please contact our customer service department at info@kisaetechnology.com or Phone 1-877-897-5778 before returning product to retail store. After speaking to a customer service representative, if products are deemed non-working or malfunctioning, the product may be returned to the purchasing store within 30 days of original purchase. Any defective unit that is returned to manufacturer within 30 days of the date of purchase will be replaced free of charge.

If such a unit is returned more than 30 days but less than one year from the purchase date, manufacturer will repair the unit or, at its option, replace it, free of charge. If the unit is repaired, new or reconditioned replacement parts may be used, at manufacturer's option. A unit may be replaced with a new or reconditioned unit of the same or comparable design. The repaired or replaced unit will then be warranted under these terms for the remainder of the warranty period. The customer is responsible for the shipping charges on all returned items.

LIMITATIONS

This warranty does not cover accessories, such as adapters and batteries, damage or defects resulting from normal wear and tear (including chips, scratches, abrasions, discoloration or fading due to usage or exposure to sunlight), accidents, damage during shipping to our service facility, alterations, unauthorized use or repair, neglect, misuse, abuse, failure to follow instructions for care and maintenance, fire and flood.

If your problem is not covered by his warranty, call our Customer Service Department at info@kisaetechnology.com or 1-877-897-5778 for general information if applicable.

Service Contact Information

Email: info@kisaetechnology.com

Phone: 1-877-897-5778

www.kisaepower.com

KISAESM

Printed in China

